



# Hybrid Inverter

SUN-5K-SG01HP3-EU-AM2

SUN-6K-SG01HP3-EU-AM2

SUN-8K-SG01HP3-EU-AM2

SUN-10K-SG01HP3-EU-AM2

SUN-12K-SG01HP3-EU-AM2

SUN-15K-SG01HP3-EU-AM2

SUN-20K-SG01HP3-EU-AM2

SUN-25K-SG01HP3-EU-AM2

## User Manual



---

# Contents

1. Safety Introductions	01
2. Product instructions	02-05
3. Installation	05-25
4. OPERATION	26
5. LCD Display Icons	27-39
6. Mode	39-40
7. Limitation of Liability	40-44
8. Datasheet	45-48
9. Appendix I	49-50
10. Appendix II	51
11. EU Declaration of Conformity	51-52

## About This Manual

The manual mainly describes the product information, guidelines for installation, operation and maintenance. The manual cannot include complete information about the photovoltaic (PV) system.

## How to Use This Manual

Read the manual and other related documents before performing any operation on the inverter. Documents must be stored carefully and be available at all times.

**Contents may be periodically updated or revised due to product development. The information in this manual is subject to change without notice.** The latest manual can be acquired via [service@deye.com.cn](mailto:service@deye.com.cn)

## 1. Safety Introductions

### Safety signs



The DC input terminals of the inverter must not be grounded.



Surface high temperature, Please do not touch the inverter case.



The AC and DC circuits must be disconnected separately, and the maintenance personnel must wait for 5 minutes before they are completely powered off before they can start working.



Prohibit disassembling inverter case, there existing shock hazard, which may cause serious injury or death, please ask qualified person to repair.



Please read the instructions carefully before use.



Do Not put it in the waste bin! Recycle it by licensed professional!

- This chapter contains important safety and operating instructions. Read and keep this manual for future reference.
- Before using the inverter, please read the instructions and warning signs of the battery and corresponding sections in the instruction manual.
- Do not disassemble the inverter. If you need maintenance or repair, take it to a professional service center.
- Improper reassembly may result in electric shock or fire.
- To reduce risk of electric shock, disconnect all wires before attempting any maintenance or cleaning. Turning off the unit will not reduce this risk.
- Caution: Only qualified personnel can install this device with battery.
- Never charge a frozen battery.
- For optimum operation of this inverter, please follow required specification to select appropriate cable size. It is very important to correctly operate this inverter.
- Be very cautious when working with metal tools on or around batteries. Dropping a tool may cause a spark or short circuit in batteries or other electrical parts, even cause an explosion.
- Please strictly follow installation procedure when you want to disconnect AC or DC terminals. Please refer to "Installation" section of this manual for the details.
- Grounding instructions - this inverter should be connected to a permanent grounded wiring system. Be sure to comply with local requirements and regulation to install this inverter.
- Never cause AC output and DC input short circuited. Do not connect to the mains when DC input short circuits.

## 2. Product Introductions

This is a multifunctional inverter, combining functions of inverter, solar charger and battery charger to offer uninterruptible power support with portable size. Its comprehensive LCD display offers user configurable and easy accessible button operation such as battery charging, AC/solar charging, and acceptable input voltage based on different applications.

### 2.1 Product Overview

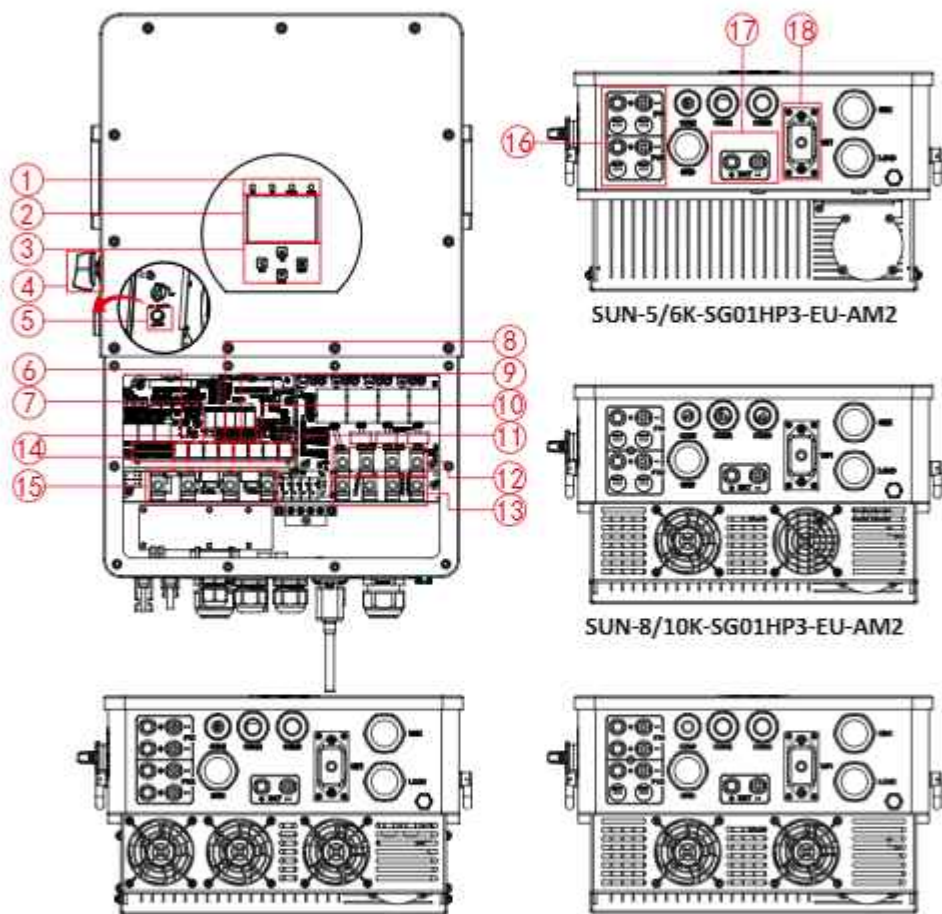

SUN-20/25K-SG01HP3-EU-AM2

SUN-12/15K-SG01HP3-EU-AM2

- |                        |                     |                            |
|------------------------|---------------------|----------------------------|
| 1: Inverter indicators | 7: Parallel port    | 13: Load                   |
| 2: LCD display         | 8: CAN port         | 14: Function port          |
| 3: Function buttons    | 9: DRM port         | 15: Grid                   |
| 4: DC switch           | 10: BMS port        | 16: PV input with two MPPT |
| 5: Power on/off button | 11: RS485 port      | 17: Battery input          |
| 6: Meter port          | 12: Generator input | 18: WiFi Interface         |

## 2.2 Product Size

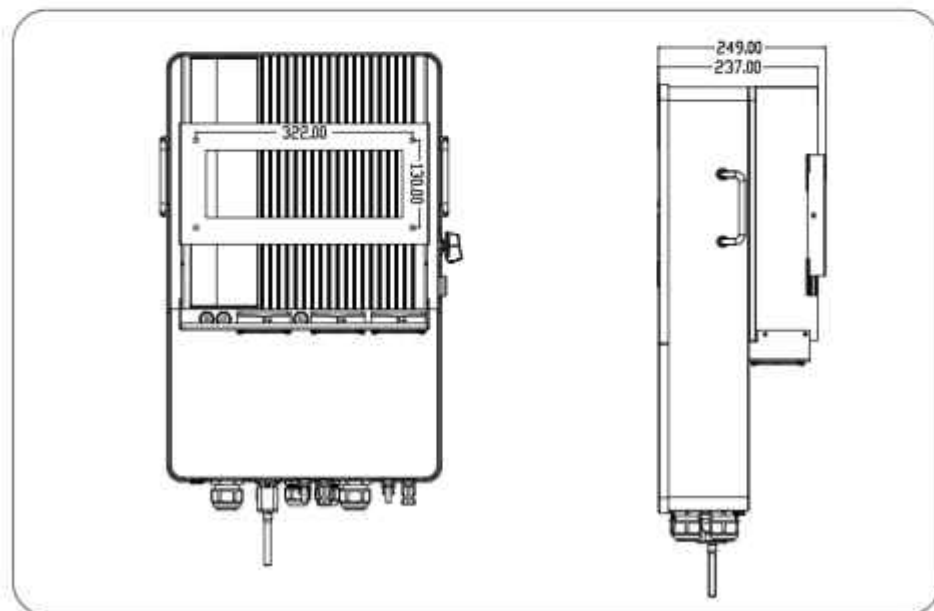
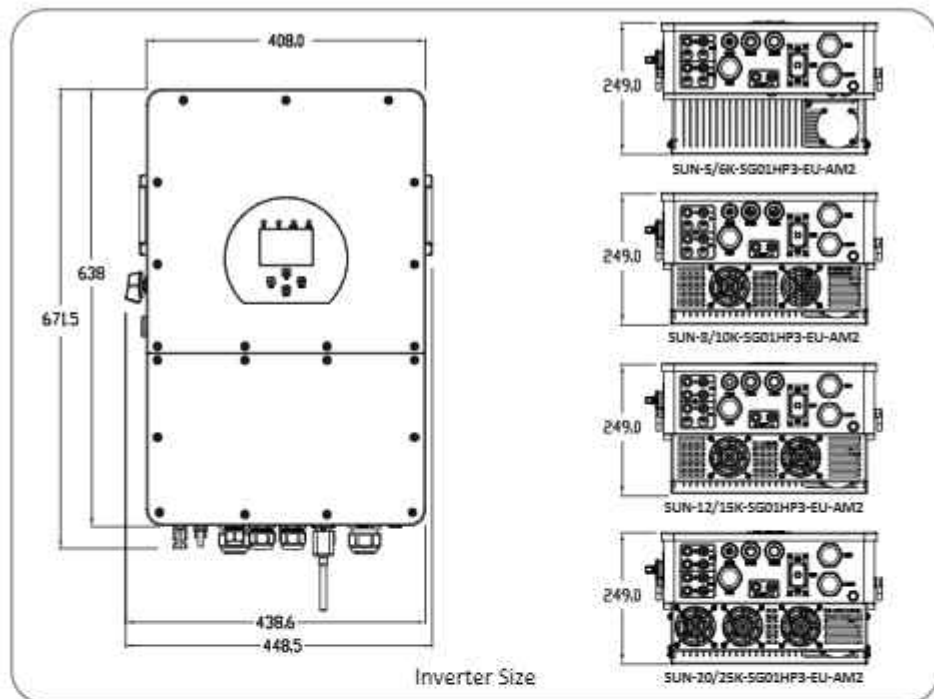

## 2.3 Product Features

- 230V/400V Three phase Pure sine wave inverter.
- Self-consumption and feed-in to the grid.
- Auto restart while AC is recovering.
- Programmable supply priority for battery or grid.
- Programmable multiple operation modes: On grid, off grid and UPS.
- Configurable battery charging current/voltage based on applications by LCD setting.
- Configurable AC/Solar/Generator Charger priority by LCD setting.
- Compatible with mains voltage or generator power.
- Overload/over temperature/short circuit protection.
- Smart battery charger design for optimized battery performance
- With limit function, prevent excess power overflow to the grid.
- Supporting WIFI monitoring and build-in 2 strings for 1 MPP tracker, 1 string for 1 MPP tracker.
- Smart settable three stages MPPT charging for optimized battery performance.
- Time of use function.
- Smart Load Function.

## 2.4 Basic System Architecture

The following illustration shows basic application of this inverter. It also includes following devices to have a complete running system.

- Generator or Utility
- PV modules

Consult with your system integrator for other possible system architectures depending on your requirements.

This inverter can power all kinds of appliances in home or office environment, including motor type appliances such as refrigerator and air conditioner.

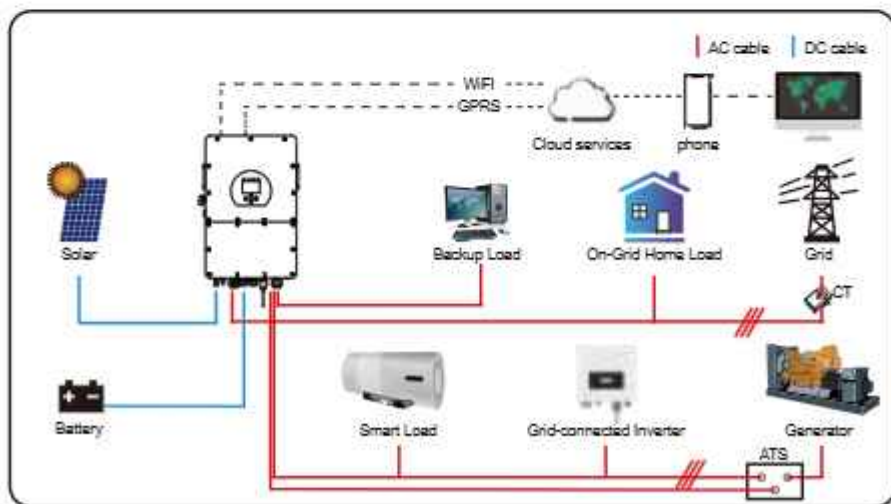

## 2.5 Product handling requirements

Two people stand on both sides of the machine, holding one handles to lift the machine.

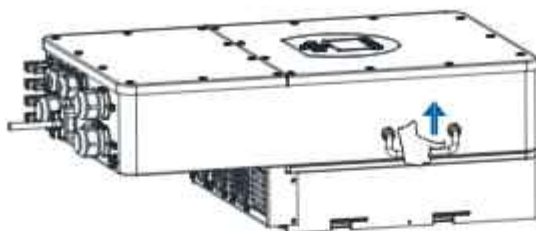









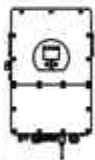



transport

## 3. Installation

### 3.1 Parts List

Check the equipment before installation. Please make sure nothing is damaged in the package. You should have received the items in the following package:

 Hybrid inverter x1	 Wall mounting bracket x1	 Stainless steel anti-collision bolt M6x60 x4	 Parallel communication cable x1
 L-type Hexagon wrench x1	 Meter (optional) x 1	 User manual x1	 Wi-Fi-Plug (optional) x1
 Sensor Clamp x 2	 Battery Plug connectors including metal terminal x2(blue)	 DC+/DC- Plug connectors including metal terminal xN(black)	 Magnetic ring for BMS communication cable x 1

## 3.2 Mounting instructions

### Installation Precaution

This Hybrid inverter is designed for outdoor use(IP65), Please make sure the installation site meets below conditions:

- Not in direct sunlight
- Not in areas where highly flammable materials are stored.
- Not in potential explosive areas.
- Not in the cool air directly.
- Not near the television Antenna or antenna cable.
- Not higher than altitude of about 2000 meters above sea level.
- Not in environment of precipitation or humidity(>95%)

Please AVOID direct sunlight, rain exposure, snow laying up during installation and operation. Before connecting all wires, please take off the metal cover by removing screws as shown below:

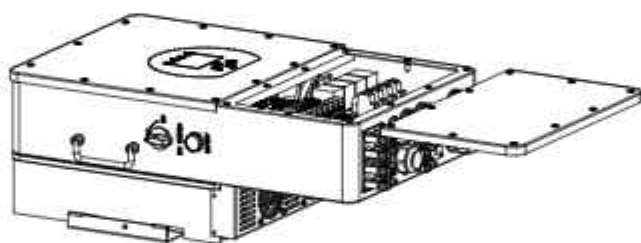

### Considering the following points before selecting where to install:

- Please select a vertical wall with load-bearing capacity for installation, suitable for installation on concrete or other non-flammable surfaces, installation is shown below.
- Install this inverter at eye level in order to allow the LCD display to be read at all times.
- The ambient temperature is recommended to be between -40~60 to ensure optimal operation.
- Be sure to keep other objects and surfaces as shown in the diagram to guarantee sufficient heat dissipation and have enough space for removing wires.



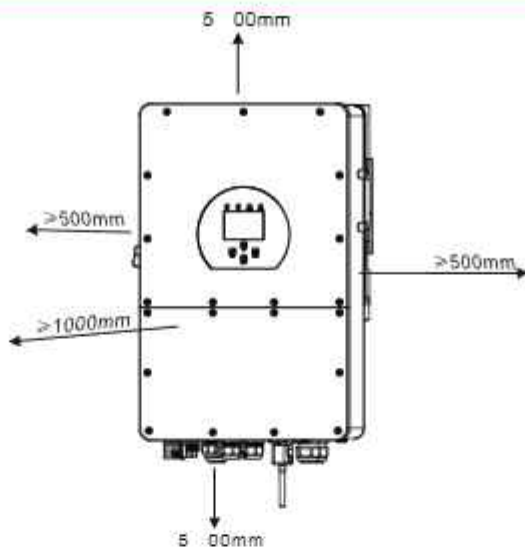

For proper air circulation to dissipate heat, allow a clearance of approx. 50cm to the side and approx. 50cm above and below the unit. And 100cm to the front.

## Mounting the inverter

Remember that this inverter is heavy! Please be careful when lifting out from the package. Choose the recommend drill head(as shown in below pic) to drill 4 holes on the wall, 62-70mm deep.

1. Use a proper hammer to fit the expansion bolt into the holes.
2. Carry the inverter and holding it, make sure the hanger aim at the expansion bolt,fix the inverter on the wall.
3. Fasten the screw head of the expansion bolt to finish the mounting.

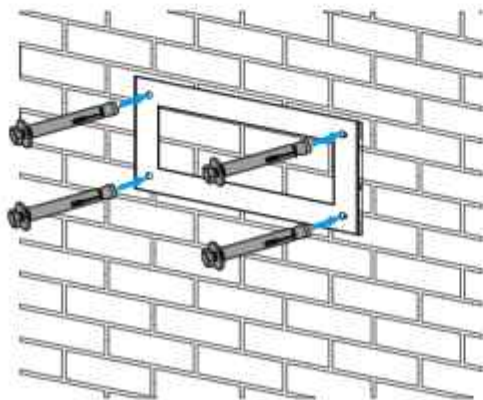

Inverter hanging plate installation

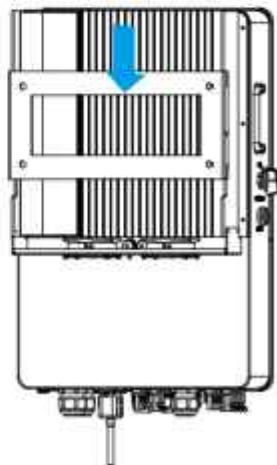

### 3.3 Battery connection

For safe operation and compliance, a separate DC over-current protector or disconnect device is required between the battery and the inverter. In some applications, switching devices may not be required but over-current protectors are still required. Refer to the typical amperage in the table below for the required fuse or circuit breaker size.

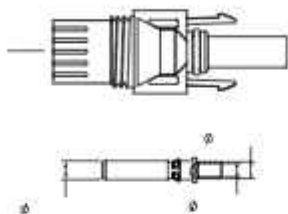

Pic 3.1 DC+ male connector

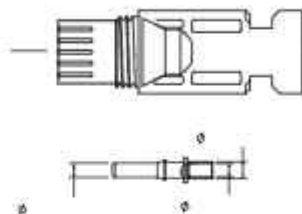

Pic 3.2 DC- female connector



**Safety Hint:**

Please use approved DC cable for battery system.

Model	Cross section <sup>2</sup>	
	Range	Recommended value
5/6/8/10/12/15/20kW	4-10 (10-6AWG)	6(8AWG)
25kW	6-16 (10-6AWG)	10(6AWG)

Chart 3-2

The steps to assemble the DC connectors are listed as follows:

- a) Strip off the DC wire about 7mm, disassemble the connector cap nut (see picture 3.3)

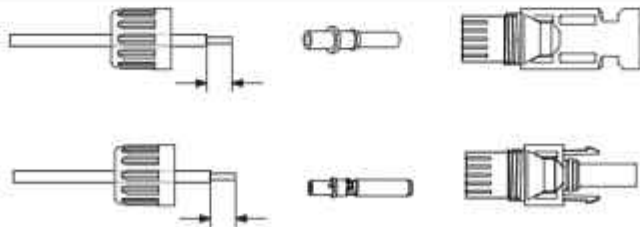

Pic 3.3 Disassemble the connector cap nut

b) Crimping metal terminals with crimping pliers as shown in picture 3.4.



Pic 3.4 Crimp the contact pin to the wire

c) Insert the contact pin to the top part of the connector and screw up the cap nut to the top part of the connector. (as shown in picture 3.5).

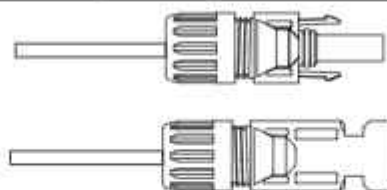

Pic 3.5 connector with cap nut screwed on

d) Finally insert the DC connector into the positive and negative input of the inverter, shown as picture 3.6

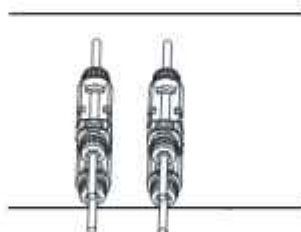

Pic 3.6 DC input connection

BMS connection



Pass the BMS communication cable through the magnetic ring and wrap it around the magnetic ring four times.

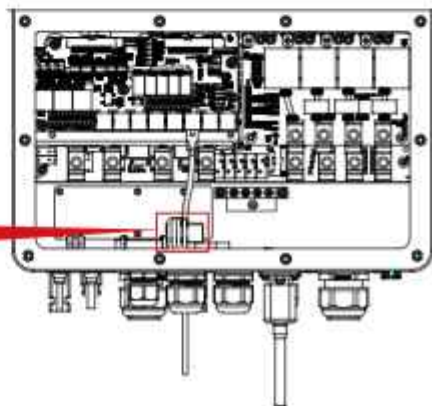

### 3.3.2 Function port definition

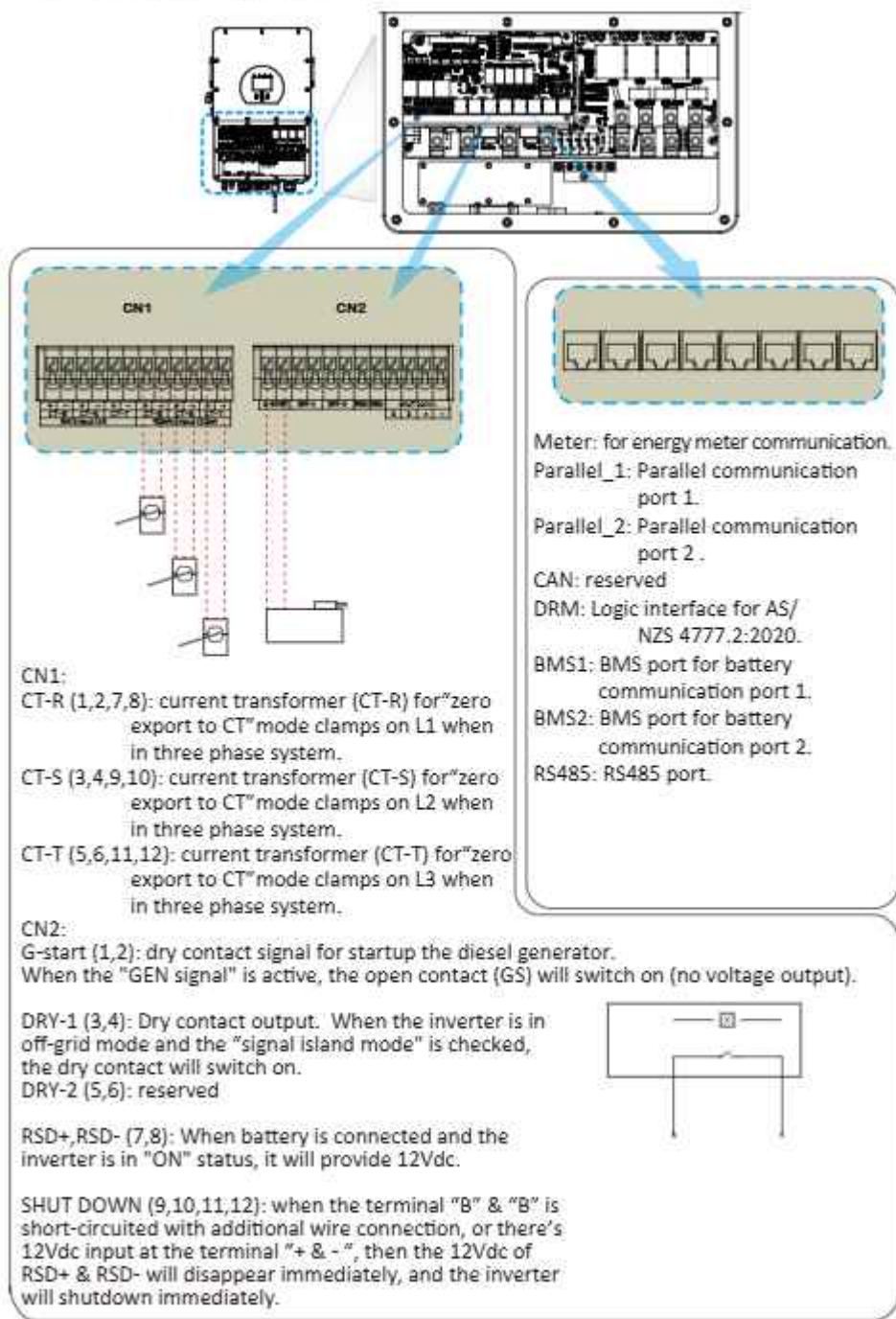

### 3.4 Grid connection and backup load connection

- Before connecting to the grid, a separate AC breaker must be installed between the inverter and the grid, and also between the backup load and the inverter. This will ensure the inverter can be securely disconnected during maintenance and fully protected from over current. For the 5/6/8/10/12/15/20/25kW model, the recommended AC breaker for backup load 5/6/8/10kW is 60A, 12/15/20/25kW is 100A. For the 5/6/8/10/12/15/20/25kW model, the recommended AC breaker for grid 5/6/8/10kW is 60A, 12/15/20/25kW is 100A.
- There are three terminal blocks with "Grid" "Load" and "GEN" markings. Please do not misconnect input and output connectors.



All wiring must be performed by a qualified personnel. It is very important for system safety and efficient operation to use appropriate cable for AC input connection. To reduce risk of injury, please use the proper recommended cable as below.

Grid connection and backup load connection (Copper wires) (bypass)

Model	Wire Size	Cable(mm <sup>2</sup> )	Torque value(max)
5/6/8/10kW	8AWG	6	3.4Nm
12/15/20/25kW	4AWG	16	4.0Nm

Grid connection and backup load connection (Copper wires)

Model	Wire Size	Cable(mm <sup>2</sup> )	Torque value(max)
5/6kW	16AWG	1.25	2.8Nm
8/10/12kW	12AWG	2.5	2.8Nm
15kW	10AWG	4.0	2.8Nm
20kW	8AWG	6.0	3.4Nm
25kW	6AWG	10	3.4Nm

Chart 3-3 Recommended Size for AC wires

**Please follow below steps to implement Grid, load and Gen port connection:**

1. Before making Grid, load and Gen port connection, be sure to turn off AC breaker or disconnecter first.
2. Remove insulation sleeve 10mm length, insert the wires according to polarities indicated on the terminal block. Make sure the connection is complete.

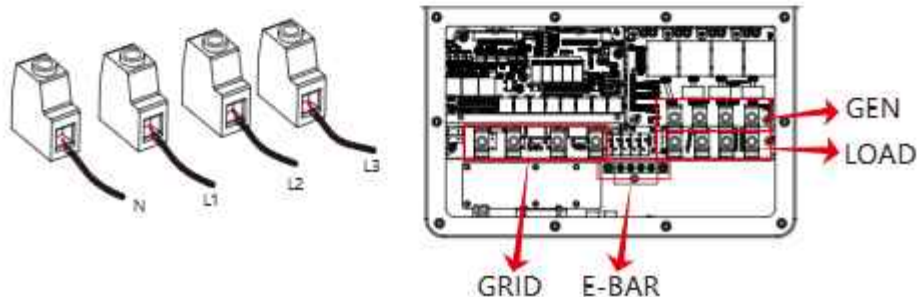



Be sure that AC power source is disconnected before attempting to wire it to the unit.

3. Then, insert AC output wires according to polarities indicated on the terminal block and tighten terminal. Be sure to connect corresponding N wires and PE wires to related terminals as well.
4. Make sure the wires are securely connected.
5. Appliances such as air conditioner are required at least 2-3 minutes to restart because it is required to have enough time to balance refrigerant gas inside of circuit. If a power shortage occurs and recovers in short time, it will cause damage to your connected appliances. To prevent this kind of damage, please check manufacturer of air conditioner if it is equipped with time-delay function before installation. Otherwise, this inverter will trigger overload fault and cut off output to protect your appliance but sometimes it still causes internal damage to the air conditioner

### 3.5 PV Connection

Before connecting to PV modules, please install a separately DC circuit breaker between inverter and PV modules. It is very important for system safety and efficient operation to use appropriate cable for PV module connection.



To avoid any malfunction, do not connect any PV modules with possible leakage current to the inverter. For example, grounded PV modules will cause leakage current to the inverter. When using PV modules, please ensure the PV+ & PV- of solar panel is not connected to the system ground bar.



It is requested to use PV junction box with surge protection. Otherwise, it will cause damage on inverter when lightning occurs on PV modules.

### 3.5.1 PV Module Selection:

When selecting proper PV modules, please be sure to consider below parameters:

- 1) Open circuit Voltage (Voc) of PV modules can not exceed max. PV array open circuit voltage of inverter.
- 2) Open circuit Voltage (Voc) of PV modules should be higher than min. start voltage.
- 3) The PV modules used to connected to this inverter shall be Class A rating certified according to IEC 61730.

<i>Inverter Model</i>	<i>5kW</i>	<i>6kW</i>	<i>8kW</i>	<i>10kW</i>	<i>12kW</i>	<i>15kW</i>	<i>20kW</i>	<i>25kW</i>
PV Input Voltage	600V (180V-1000V)							700V (180V-1000V)
PV Array MPPT Voltage Range	150V-850V							
No. of MPP Trackers	2							
No. of Strings per MPP Tracker	1+1			2+1			2+2	

Chart 3-5

### 3.5.2 PV Module Wire Connection:

1. Switch the Grid Supply Main Switch(AC)OFF.
2. Switch the DC Isolator OFF.
3. Assemble PV input connector to the inverter.



**Safety Hint:**

When using PV modules, please ensure the PV+ & PV- of solar panel is not connected to the system ground bar.



**Safety Hint:**

Before connection, please make sure the polarity of PV array matches the "DC+" and "DC-" symbols.



**Safety Hint:**

Before connecting inverter, please make sure the PV array open circuit voltage is within the 1000V of the inverter.

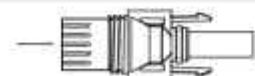

Pic 5.1 DC+ male connector

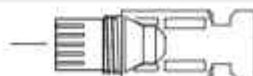

Pic 5.2 DC- female connector



**Safety Hint:**

Please use approved DC cable for PV system.

Cable type	Cross section <sup>3</sup>	
	Range	Recommended value
Industry generic PV cable (model: PV1-F)	2.5-4 (12-10AWG)	4(10AWG)

Chart 3-6

The steps to assemble the DC connectors are listed as follows:

- a) Strip off the DC wire about 7mm, disassemble the connector cap nut (see picture 5.3)

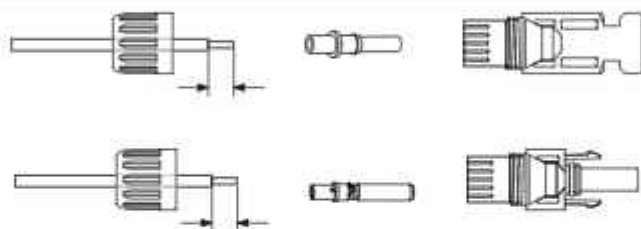

Pic 5.3 Disassemble the connector cap nut

- b) Crimping metal terminals with crimping pliers as shown in picture 5.4.

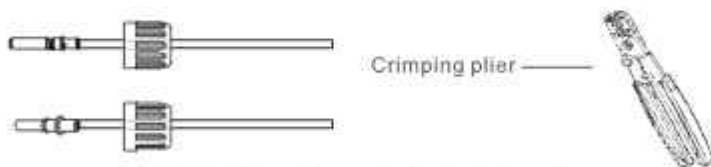

Pic 5.4 Crimp the contact pin to the wire

- c) Insert the contact pin to the top part of the connector and screw up the cap nut to the top part of the connector. (as shown in picture 5.5).



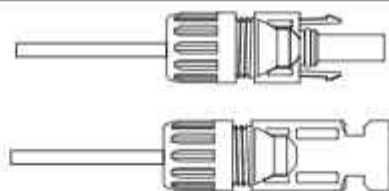

Pic 5.5 connector with cap nut screwed on

d) Finally insert the DC connector into the positive and negative input of the inverter, shown as picture 5.6

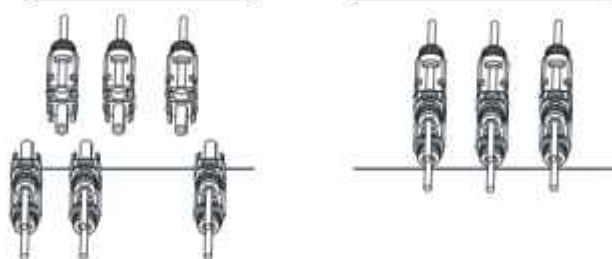

Pic 5.6 DC input connection



**Warning:**

Sunlight shines on the panel will generate voltage, high voltage in series may cause danger to life. Therefore, before connecting the DC input line, the solar panel needs to be blocked by the opaque material and the DC switch should be 'OFF', otherwise, the high voltage of the inverter may lead to life-threatening conditions. Please do not switch off DC isolator when the DC current when there is high voltage or current. Technicians need to wait until night to keep safety.



**Warning:**

Please use its own DC power connector from the inverter accessories. Do not interconnect the connectors of different manufacturers. Max. DC input current should be 20A. if exceeds, it may damage the inverter and it is not covered by Deye warranty.

### 3.6 CT Connection

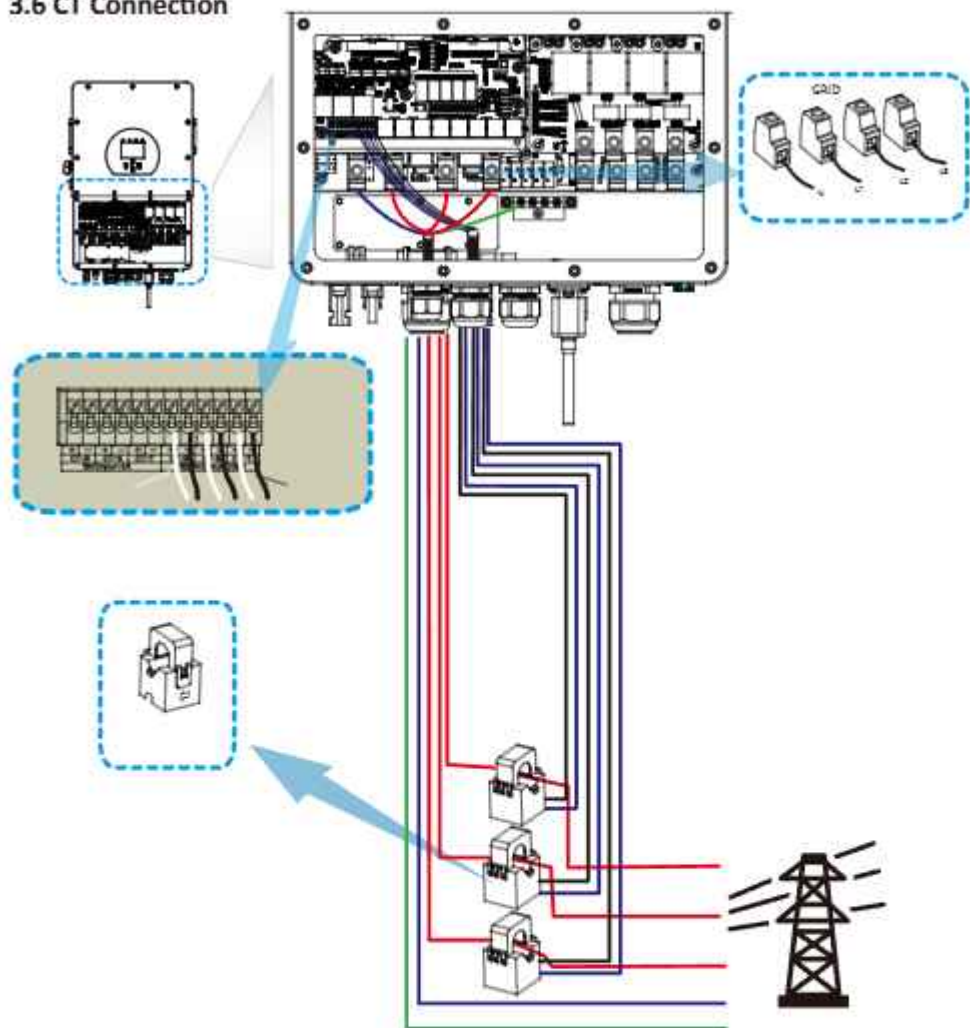

\*Notewhen the reading of the load power on the LCD is not correct, please reverse the CT arrow.

### 3.6.1 Meter Connection

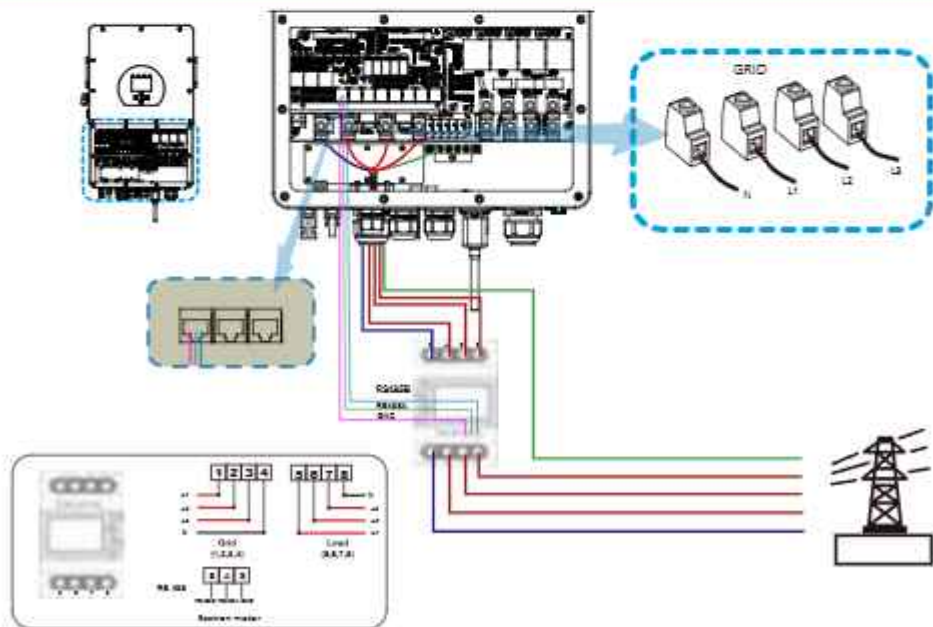
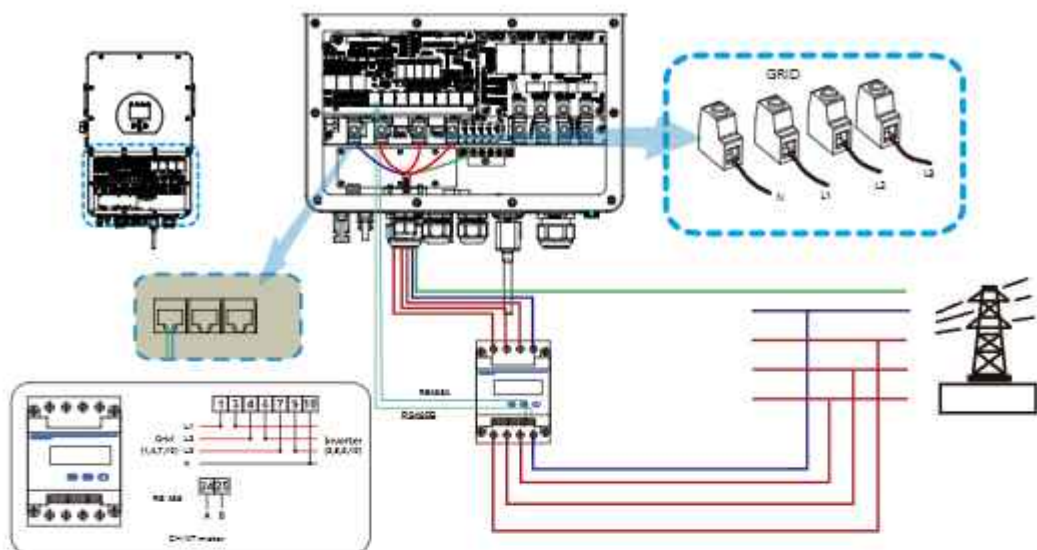

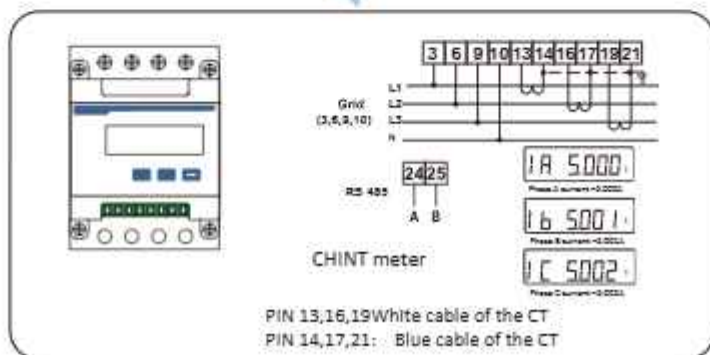
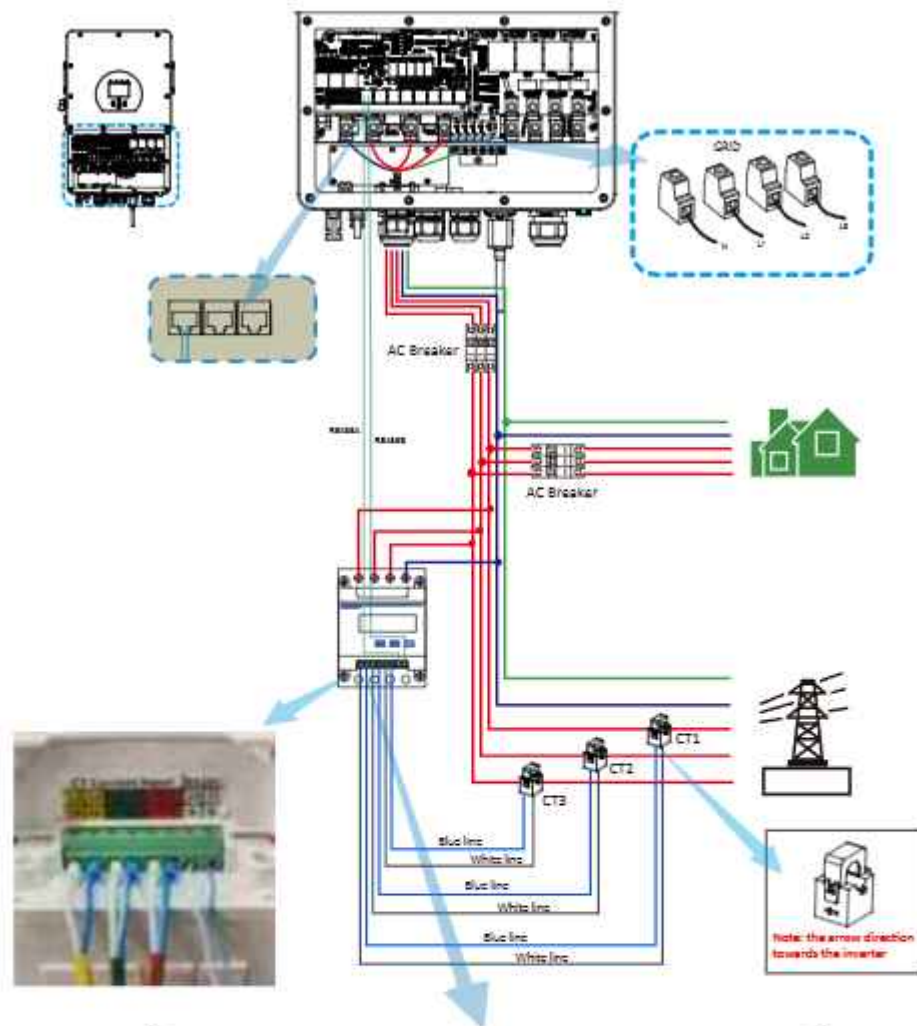

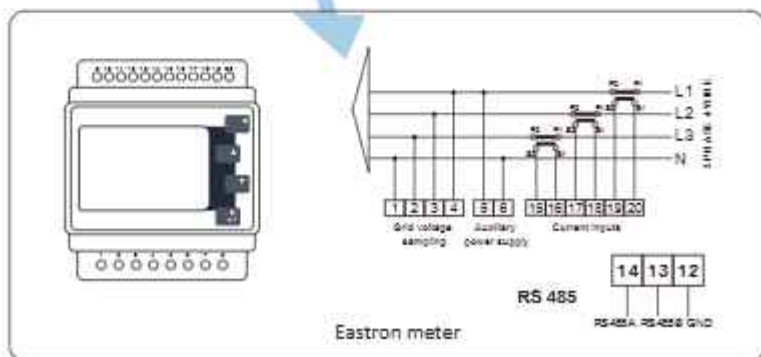
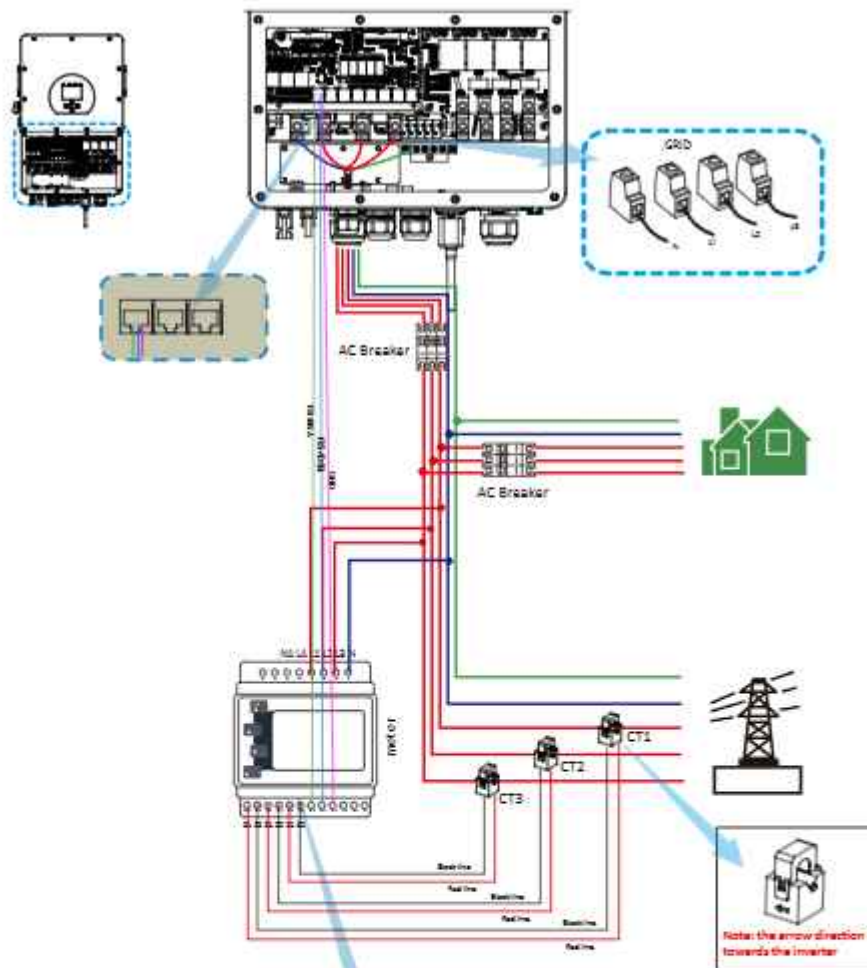

**Note:**

When the inverter is in the off-grid state, the N line needs to be connected to the earth.

**Note:**

In final installation, breaker certified according to IEC 60947-1 and IEC 60947-2 shall be installed with the equipment.

### 3.7 Earth Connection(mandatory)

Ground cable shall be connected to ground plate on grid side this prevents electric shock if the original protective conductor fails.

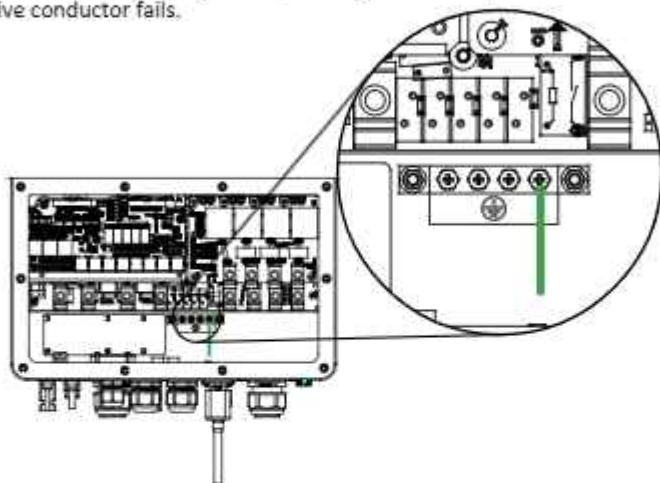

Earth Connection (Copper wires) (bypass)

Model	Wire Size	Cable(mm <sup>2</sup> )	Torque value(max)
5/6/8/10kW	8AWG	6	3.4Nm
12/15/20/25kW	4AWG	16	4.0Nm

Earth Connection (Copper wires)

Model	Wire Size	Cable(mm <sup>2</sup> )	Torque value(max)
5/6kW	16AWG	1.25	2.8Nm
8/10/12kW	12AWG	2.5	2.8Nm
15kW	10AWG	4.0	2.8Nm
20kW	8AWG	6.0	3.4Nm
25kW	6AWG	10	3.4Nm

The conductor should be made of the same metal as the phase conductors.

### 3.8 WiFi Connection

For the configuration of Wi-Fi Plug, please refer to illustrations of the Wi-Fi Plug. The Wi-Fi Plug is not a standard configuration, it's optional.

### 3.9 Wiring System for Inverter

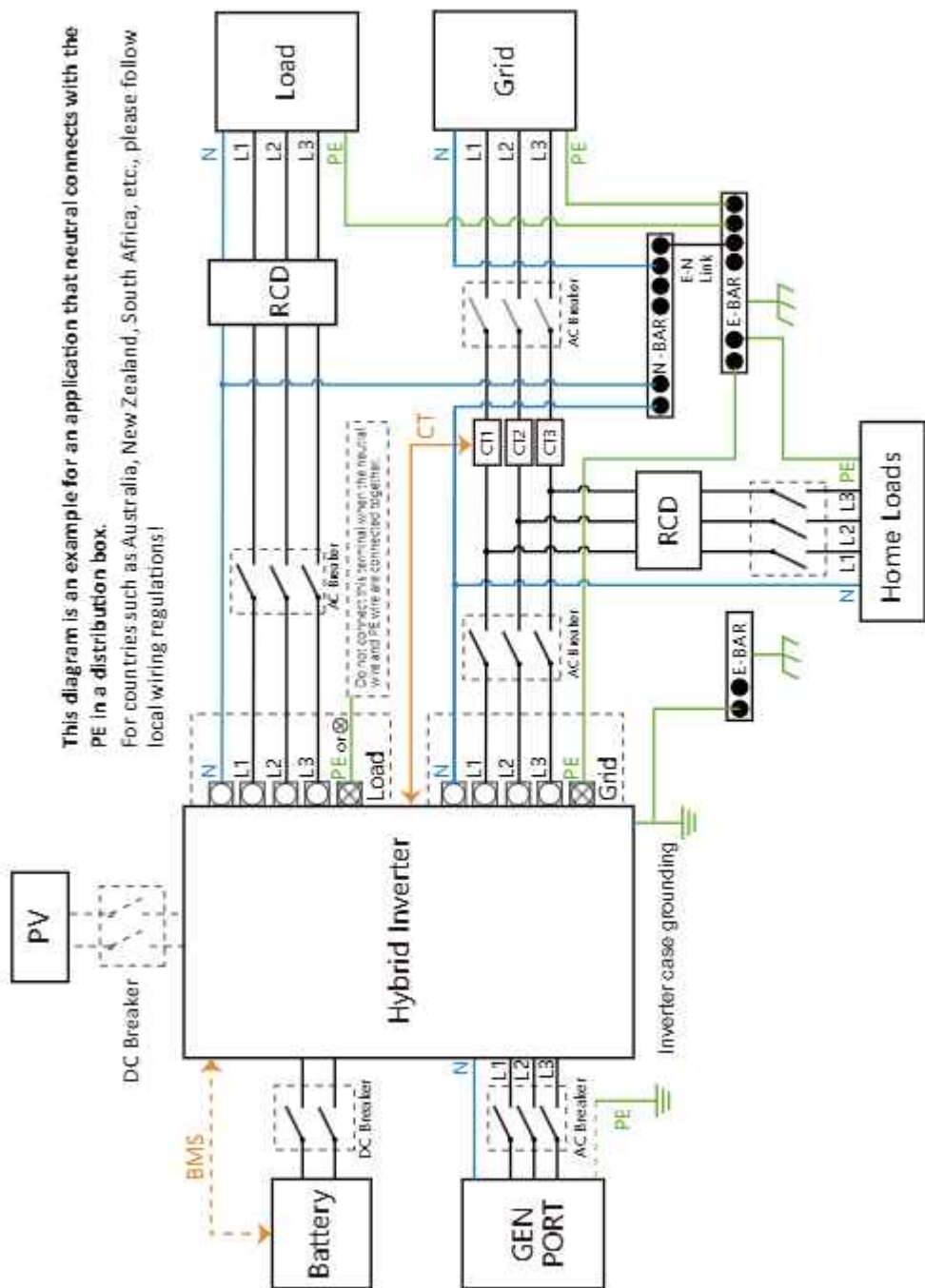

This diagram is an example for an application that neutral connects with the PE in a distribution box.

For countries such as Australia, New Zealand, South Africa, etc., please follow local wiring regulations!

### 3.10 Wiring diagram

This diagram is an example for an application in which neutral is separated from the PE in the distribution box. For countries such as China, Germany, the Czech Republic, Italy, etc., please follow local wiring regulations!

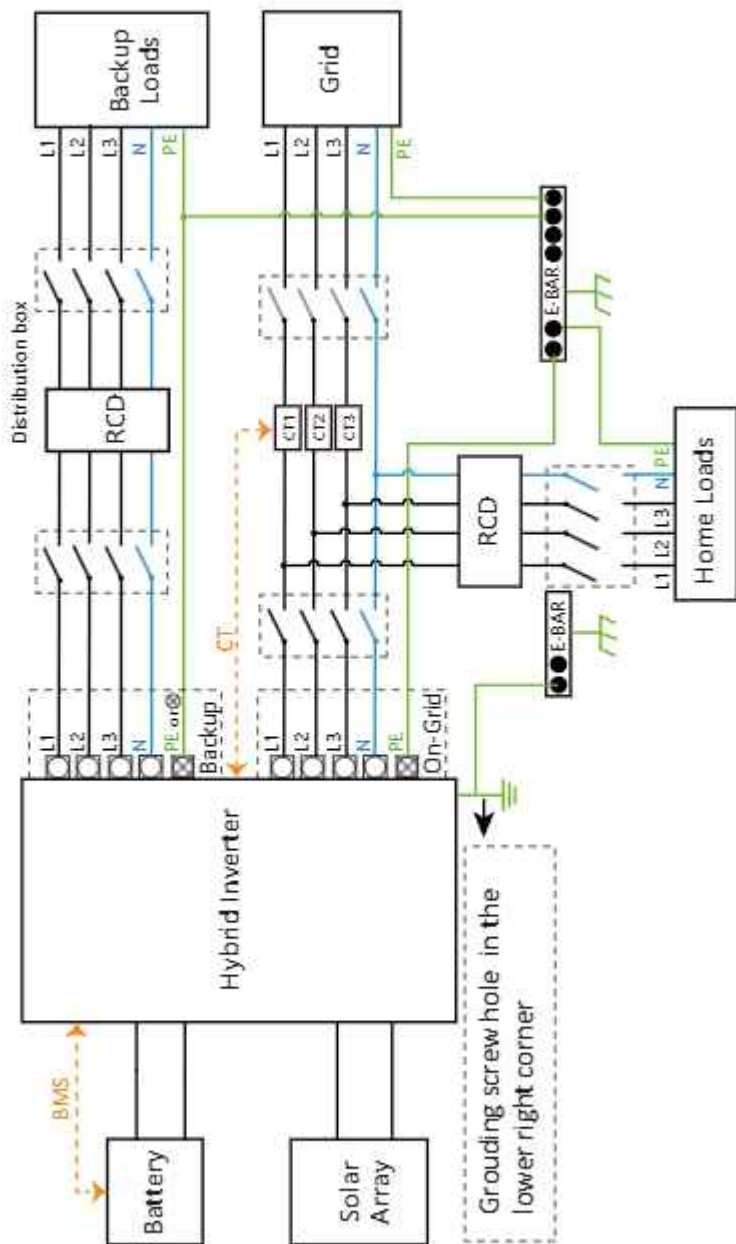



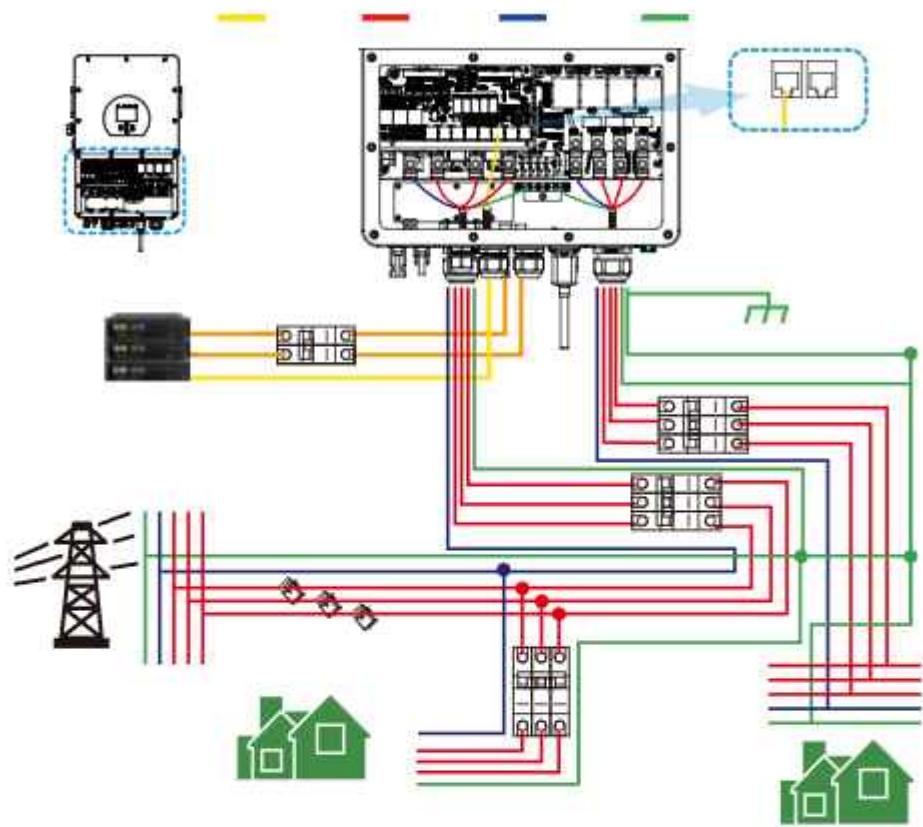

### 3.11 Typical application diagram of diesel generator

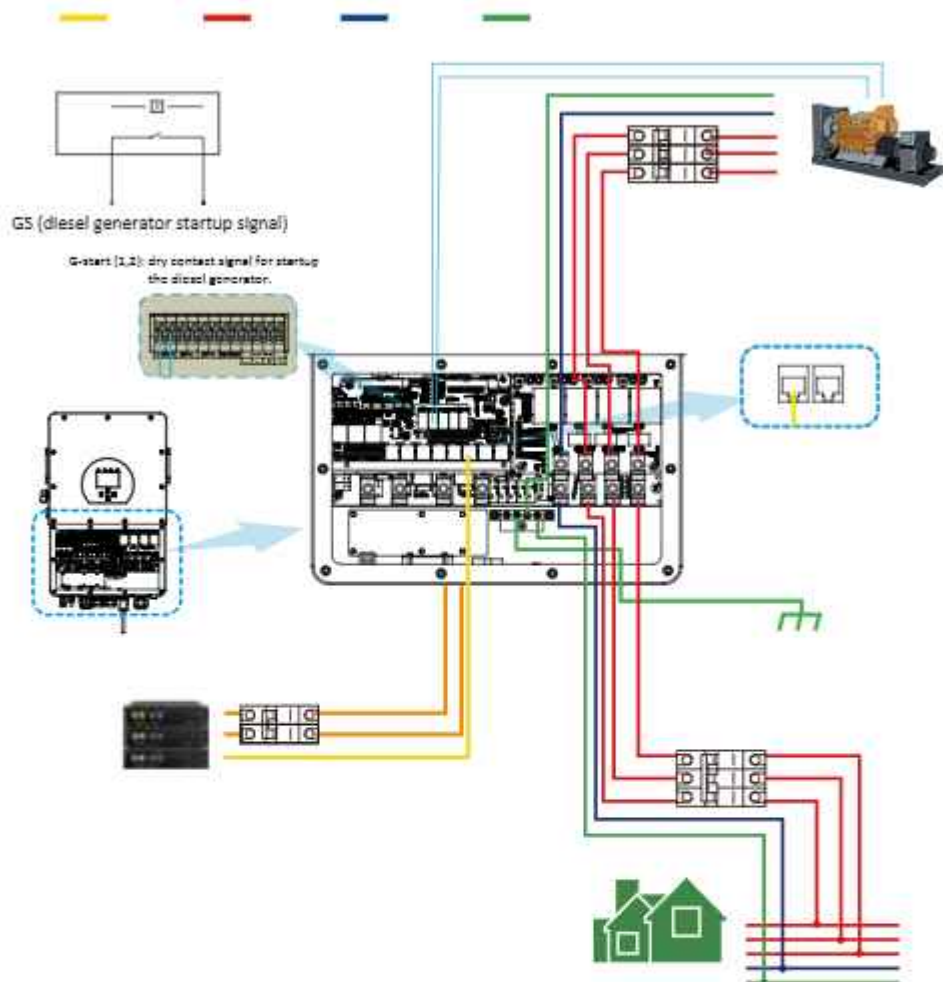

### 3.12 Three phase parallel connection diagram

Note: For the parallel system, the lead-acid battery is not supported. Please use Deye approved lithium battery.

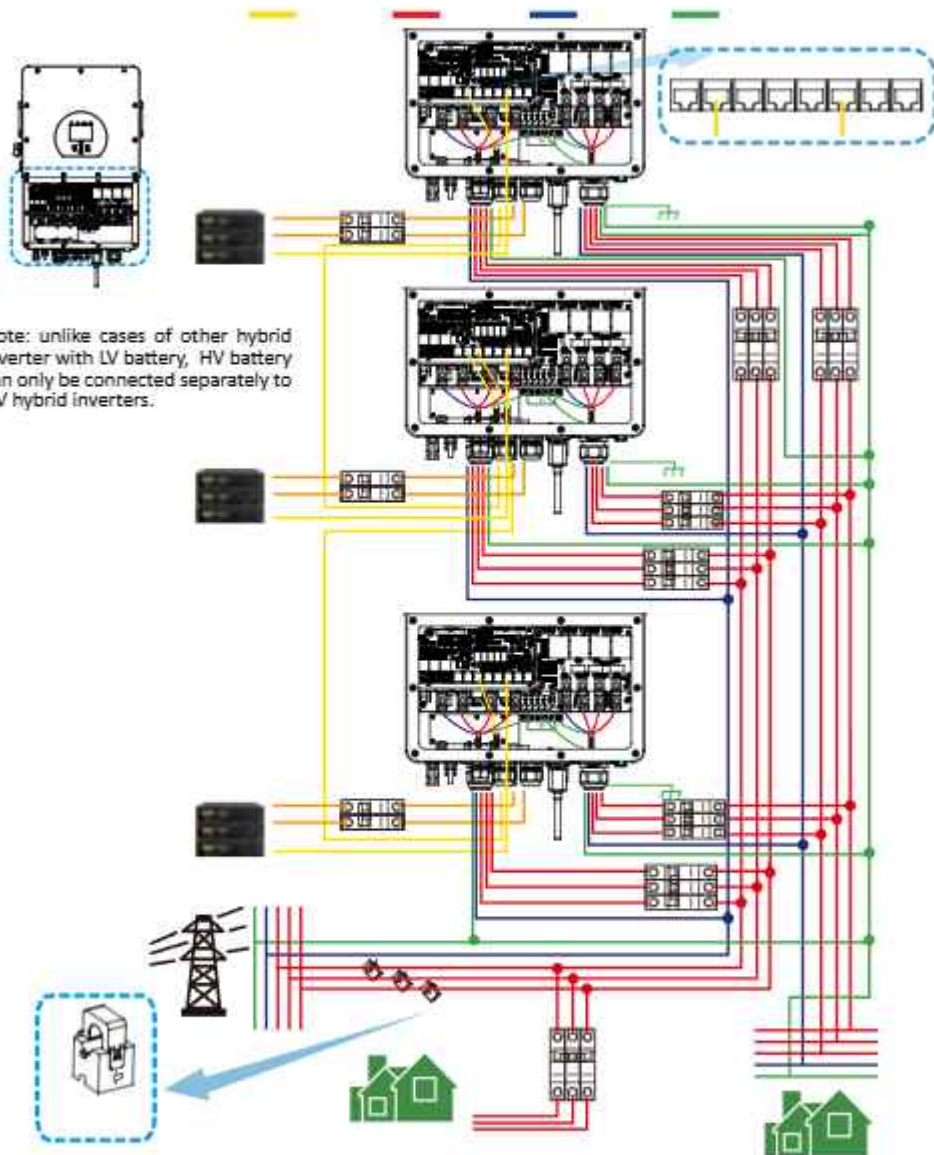

Note: unlike cases of other hybrid inverter with LV battery, HV battery can only be connected separately to HV hybrid inverters.



## 4. OPERATION

### 4.1 Power ON/OFF

Once the unit has been properly installed and the batteries are connected well, simply press On/Off button(located on the left side of the case) to turn on the unit. When system without battery connected, but connect with either PV or grid, and ON/OFF button is switched off, LCD will still light up(Display will show OFF). In this condition, when switch on ON/OFF button and select NO battery,system can still working.

### 4.2 Operation and Display Panel

The operation and display panel, shown in below chart, is on the front panel of the inverter. It includes four indicators, four function keys and a LCD display, indicating the operating status and input/output power information.

<i>LED Indicator</i>		<i>Messages</i>
DC	Green led solid light	PV Connection normal
AC	Green led solid light	Grid Connection normal
Normal	Green led solid light	Inverter operating normal
Alarm	Red led solid light	Malfunction or warning

Chart 4-1 LED indicators

<i>Function Key</i>	<i>Description</i>
Esc	To exit setting mode
Up	To go to previous selection
Down	To go to next selection
Enter	To confirm the selection

Chart 4-2 Function Buttons

## 5. LCD Display Icons

### 5.1 Main Screen

The LCD is touchscreen, below screen shows the overall information of the inverter.



1.The icon in the center of the home screen indicates that the system is Normal operation: If it turns into "comm./F01~F64", it means the inverter has communication errors or other errors, the error message will display under this icon(F01-F64 errors, detail error info can be viewed in the System Alarms menu).

2.At the top of the screen is the time.

3.System Setup Icon, Press this set button,you can enter into the system setup screen which including Basic Setup, Battery Setup, Grid Setup, System Work Mode, Generator port use, Advanced function and Li-Batt Info.

4.The main screen showing the info including Solar, Grid, Load and Battery. Its also displaying the energy flow direction by arrow. When the power is approximate to high level, the color on the panels will changing from green to red so system info showing vividly on the main screen.

- PV power and Load power always keep positive.
- Grid power negative means sell to grid, positive means get from grid.
- Battery power negative means charge, positive means discharge.

### 5.1.1 LCD operation flow chart

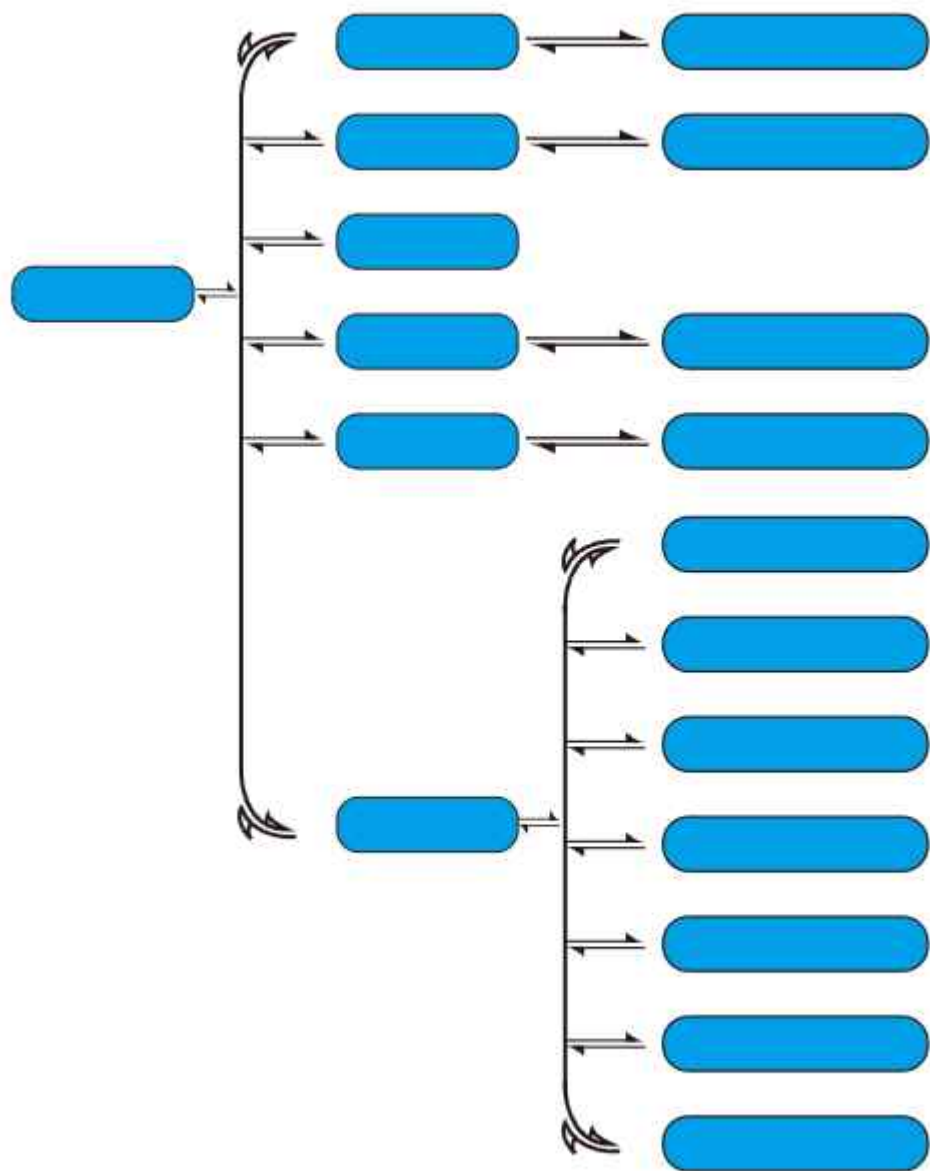

## 5.2 Solar Power Curve

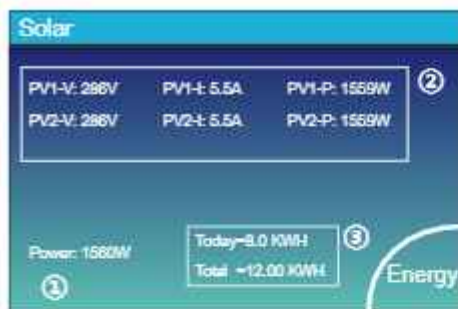

This is Solar Panel detail page.

- ① Solar Panel Generation.
- ② Voltage, Current, Power for each MPPT.
- ③ Daily and total PV production

Press the "Energy" button will enter into the power curve page.



This is Inverter detail page.

- ① Inverter Generation.  
Voltage, Current, Power for each Phase.  
AC-T: mean Heat-sink temperature.

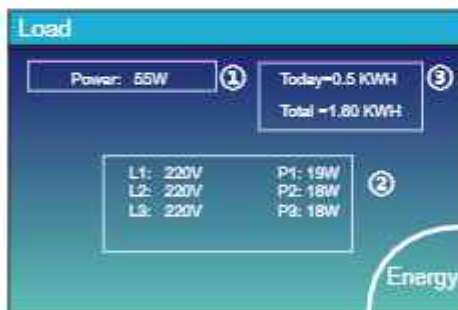

This is Load detail page.

- ① Load Power.
- ② Voltage, Power for each Phase.
- ③ Daily and total Load consumption .

When you check "Selling First" or "Zero export to Load" on system work mode page, the information on this page is about backup load which connect on Load port of hybrid inverter.  
 When you check "Zero export to CT" on system work mode page, the information on this page is including backup load and home load.

Press the "Energy" button will enter into the power curve page.



This is Grid detail page.

- ① Status, Power, Frequency.
- ② L: Voltage for each Phase  
CT: Power detected by the external current sensors  
LD: Power detected using internal sensors on AC grid in/out breaker
- ③ BUY: Energy from Grid to Inverter,  
SELL: Energy from Inverter to grid.

Press the "Energy" button will enter into the power curve page.

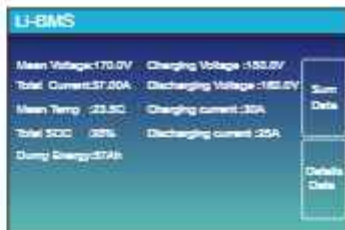

### LI-BMS

	Volt	Cur	Temp	SOC	Energy	Charge	Fault
1	168.0V	16.70A	20.0C	92.7%	18.20Wh	0.00A	000
2	168.0V	16.70A	20.0C	92.7%	18.20Wh	0.00A	000
3	168.0V	16.70A	20.0C	92.7%	18.20Wh	0.00A	000
4	0.00V	0.00A	0.0C	0.0%	0.00Wh	0.00A	000
5	0.00V	0.00A	0.0C	0.0%	0.00Wh	0.00A	000
6	0.00V	0.00A	0.0C	0.0%	0.00Wh	0.00A	000
7	0.00V	0.00A	0.0C	0.0%	0.00Wh	0.00A	000
8	0.00V	0.00A	0.0C	0.0%	0.00Wh	0.00A	000
9	0.00V	0.00A	0.0C	0.0%	0.00Wh	0.00A	000
10	0.00V	0.00A	0.0C	0.0%	0.00Wh	0.00A	000
11	0.00V	0.00A	0.0C	0.0%	0.00Wh	0.00A	000
12	0.00V	0.00A	0.0C	0.0%	0.00Wh	0.00A	000
13	0.00V	0.00A	0.0C	0.0%	0.00Wh	0.00A	000
14	0.00V	0.00A	0.0C	0.0%	0.00Wh	0.00A	000
15	0.00V	0.00A	0.0C	0.0%	0.00Wh	0.00A	000
16	0.00V	0.00A	0.0C	0.0%	0.00Wh	0.00A	000
17	0.00V	0.00A	0.0C	0.0%	0.00Wh	0.00A	000
18	0.00V	0.00A	0.0C	0.0%	0.00Wh	0.00A	000
19	0.00V	0.00A	0.0C	0.0%	0.00Wh	0.00A	000
20	0.00V	0.00A	0.0C	0.0%	0.00Wh	0.00A	000

Sum Data  
Details Data

This is Battery detail page.

If you use Lithium Battery, you can enter BMS page.

## 5.3 Curve Page-Solar & Load & Grid

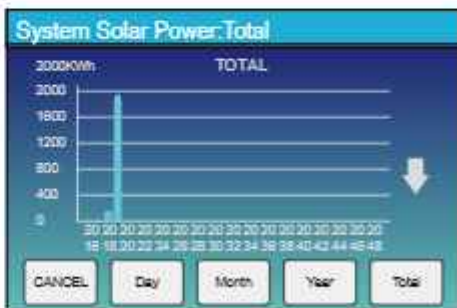
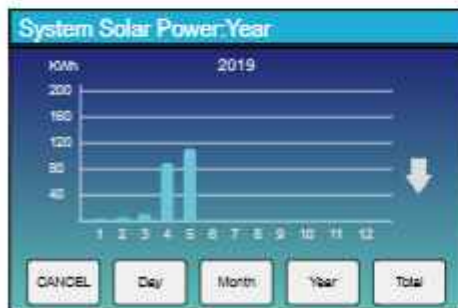
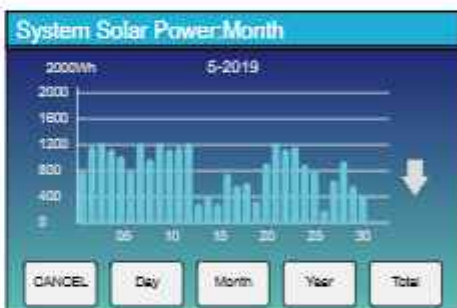
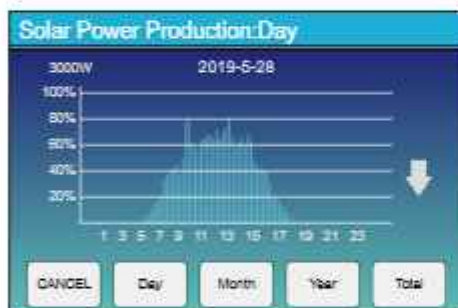

Solar power curve for daily, monthly, yearly and total can be roughly checked on the LCD, for more accuracy power generation, pls check on the monitoring system. Click the up and down arrow to check power curve of different period.



## 5.4 System Setup Menu



This is System Setup page.

## 5.5 Basic Setup Menu



**Factory Reset:** Reset all parameters of the inverter.  
**Lock out all changes:** Enable this menu for setting parameters that require locking and cannot be set up. Before performing a successful factory reset and locking the systems, to keep all changes you need to type in a password to enable the setting. The password for factory settings is 9999 and for lock out is 7777.



**Factory Reset Password:** 9999

**Lock out all changes Password:** 7777

## 5.6 Battery Setup Menu

**Battery capacity:** it shows your battery bank size to Deye hybrid inverter.

**Use Batt V:** Use Battery Voltage for all the settings (V).

**Max. A charge/discharge:** Max battery charge/discharge current (0-30A for 5/6kW model, 0-37A for 8/10/12/15/20kW model, 0-50A for 25kW model).

For AGM and Flooded, we recommend Ah battery size x 20% = Charge/Discharge amps.

For Lithium, we recommend Ah battery size x 50% = Charge/Discharge amps.

For Gel, follow manufacturer's instructions.

**No Batt:** tick this item if no battery is connected to the system.

**Parallel bat1&bat2:** if one set of battery was connected Bat 1 and Bat 2 then please enable this function.

This is Battery Setup page. ① ③

**Start =30%:** Percent SOC below 30% system will AutoStart a connected generator to charge the battery bank.

**A = 20A:** Charge rate of 20A from the attached generator in Amps.

**Gen Charge:** uses the gen input of the system to charge battery bank from an attached generator.

**Gen Signal:** Normally open relay that closes when the Gen Start signal state is active.

**Gen Max Run Time:** It indicates the longest time Generator can run in one day, when time is up, the Generator will be turned off. 24H means that it does not shut down all the time.

**Gen Down Time:** It indicates the delay time of the Generator to shut down after it has reached the running time.

This is Grid Charge, you need select. ②

**Start =30%:** No use just for customization.

**A = 37A:** It indicates the Current that the Grid charges the Battery.

**Grid Charge:** It indicates that the grid charges the battery.

**Grid Signal:** Disable.



This page tells the PV and diesel generator power the load and battery.

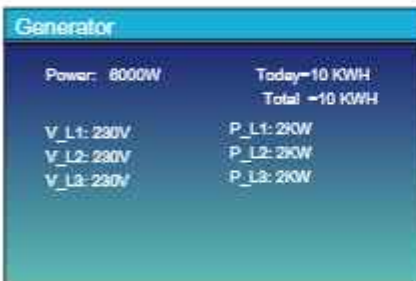

This page tells generator output voltage, frequency, power. And, how much energy is used from generator.

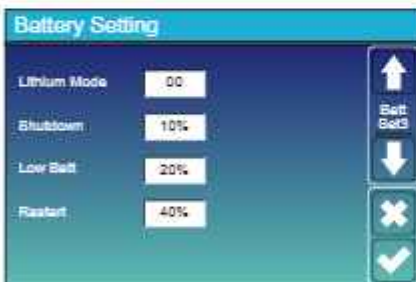

**Lithium Mode:** This is BMS protocol. Please reference the document (Approved Battery).

**Shutdown 10%:** It indicates the inverter will shutdown if the SOC below this value.

**Low Batt 20%:** It indicates the inverter will alarm if the SOC below this value.

**Restart 40%:** Battery SOC at 40% AC output will resume.

#### Recommended battery settings

Battery Type	Absorption Stage	Float Stage	Torque value (every 30 days 3hr)
Lithium	Follow its BMS voltage parameters		

## 5.7 System Work Mode Setup Menu

**System Work Mode**

Selling First    12000    Max Solar Power

Zero Export To Load     Solar Sell

Zero Export To CT     Solar Sell

Max Sell Power: 12000    Zero-Export Power: 20

Energy pattern:  BattFirst     LoadFirst

Grid Peak Shaving: 8000    Power

Work Mode 1

### Work Mode

**Selling First:** This Mode allows hybrid inverter to sell back any excess power produced by the solar panels to the grid. If time of use is active, the battery energy also can be sold into grid.

The PV energy will be used to power the load and charge the battery and then excess energy will flow to grid. Power source priority for the load is as follows:

1. Solar Panels.
2. Grid.
3. Batteries (until programable % discharge is reached).

**Zero Export To Load:** Hybrid inverter will only provide power to the backup load connected. The hybrid inverter will neither provide power to the home load nor sell power to grid. The built-in CT will detect power flowing back to the grid and will reduce the power of the inverter only to supply the local load and charge the battery.

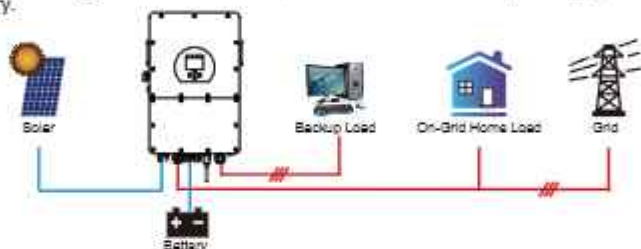

**Zero Export To CT:** Hybrid inverter will not only provide power to the backup load connected but also give power to the home load connected. If PV power and battery power is insufficient, it will take grid energy as supplement. The hybrid inverter will not sell power to grid. In this mode, a CT is needed. The installation method of the CT please refer to chapter 3.6 CT Connection. The external CT will detect power flowing back to the grid and will reduce the power of the inverter only to supply the local load, charge battery and home load.



**Solar Sell:** "Solar sell" is for Zero export to load or Zero export to CT: when this item is active, the surplus energy can be sold back to grid. When it is active, PV Power source priority usage is as follows: load consumption and charge battery and feed into grid.

**Max. sell power:** Allowed the maximum output power to flow to grid

**Zero-export Power:** for zero-export mode, it tells the grid output power. Recommend to set it as 20-100W to ensure the hybrid inverter won't feed power to grid.

**Energy Pattern:** PV Power source priority.

**Batt First:** PV power is firstly used to charge the battery and then used to power the load. If PV power is insufficient, grid will make supplement for battery and load simultaneously.

**Load First:** PV power is firstly used to power the load and then used to charge the battery. If PV power is insufficient, Grid will provide power to load.

**Max Solar Power:** allowed the maximum DC input power

**Grid Peak-shaving:** when it is active, grid output power will be limited within the set value. If the load power exceeds the allowed value, it will take PV energy and battery as supplement. If still can't meet the load requirement, grid power will increase to meet the load needs.

### System Work Mode

Grid Charge	Gen	Time Of Use		Time	Power	Batt
<input type="checkbox"/>	<input type="checkbox"/>	<input checked="" type="checkbox"/>		00:00	08:00	12000 160V
<input type="checkbox"/>	<input type="checkbox"/>	<input type="checkbox"/>		05:00	08:00	12000 160V
<input checked="" type="checkbox"/>	<input type="checkbox"/>	<input type="checkbox"/>		08:00	10:00	12000 160V
<input checked="" type="checkbox"/>	<input type="checkbox"/>	<input type="checkbox"/>		10:00	18:00	12000 160V
<input checked="" type="checkbox"/>	<input type="checkbox"/>	<input type="checkbox"/>		15:00	18:00	12000 160V
<input checked="" type="checkbox"/>	<input type="checkbox"/>	<input type="checkbox"/>		18:00	00:00	12000 160V

Work Mode2

**Time of use:** it is used to program when to use grid or generator to charge the battery, and when to discharge the battery to power the load. Only tick "Time Of Use" then the follow items (Grid, charge, time, power etc.) will take effect.

**Note:** when in selling first mode and click time of use, the battery power can be sold into grid.

**Gen charge:** utilize diesel generator to charge the battery in a time period.

**Time:** real time, range of 01:00-24:00.

**Note:** when the grid is present, only the "time of use" is ticked, then the battery will discharge. Otherwise, the battery won't discharge even the battery SOC is full. But in the off-grid mode (when grid is not available, inverter will work in the off-grid mode automatically), the battery will discharge without selecting the "Time Of Use".

**Power:** Max. discharge power of battery allowed.

**Batt(V or SOC %):** battery SOC % or voltage at when the action is to happen.

### Battery Setting

Start

A

Gen Charge  Grid Charge

Gen Signal  Grid Signal

Gen Max Run Time

Gen Down Time

Batt Set2

**For example**

During 00:00-05:00,

if battery SOC is lower than 80%, it will use grid to charge the battery until battery SOC reaches 80%.

During 05:00-08:00,

if battery SOC is higher than 40%, hybrid inverter will discharge the battery until the SOC reaches 40%. At the same time,

if battery SOC is lower than 40%, then grid will charge the battery SOC to 40%.

During 08:00-10:00,

if battery SOC is higher than 40%, hybrid inverter will discharge the battery until the SOC reaches 40%.

During 10:00-15:00,

when battery SOC is higher than 80%, hybrid inverter will discharge the battery until the SOC reaches 80%.

During 15:00-18:00,

when battery SOC is higher than 40%, hybrid inverter will discharge the battery until the SOC reaches 40%.

During 18:00-00:00,

when battery SOC is higher than 35%, hybrid inverter will discharge the battery until the SOC reaches 35%.

### System Work Mode

Grid Charge	Gen	Time Of Use		Time	Power	Batt
<input checked="" type="checkbox"/>	<input type="checkbox"/>	<input checked="" type="checkbox"/>		00:00	05:00	12000 80%
<input checked="" type="checkbox"/>	<input type="checkbox"/>	<input type="checkbox"/>		05:00	08:00	12000 40%
<input type="checkbox"/>	<input type="checkbox"/>	<input type="checkbox"/>		08:00	10:00	12000 40%
<input checked="" type="checkbox"/>	<input type="checkbox"/>	<input type="checkbox"/>		10:00	15:00	12000 80%
<input type="checkbox"/>	<input type="checkbox"/>	<input type="checkbox"/>		18:00	18:00	12000 40%
<input type="checkbox"/>	<input type="checkbox"/>	<input type="checkbox"/>		18:00	00:00	12000 35%

Work Mode2

### System Work Mode

Mon	Tue	Wed	Thu	Fri	Sat	Sun
<input checked="" type="checkbox"/>	<input checked="" type="checkbox"/>	<input checked="" type="checkbox"/>	<input checked="" type="checkbox"/>	<input checked="" type="checkbox"/>	<input checked="" type="checkbox"/>	<input type="checkbox"/>

Work Mode4

It allows users to choose which day to execute the setting of "Time of Use".

For example, the inverter will execute the time of use page on Mon/Tue/Wed/Thu/Fri/Sat only.

## 5.8 Grid Setup Menu

**Grid Setting/Grid code selection**

Grid Mode: General Standard 0/23

Grid Frequency: 50HZ Phase Type: 0/120/240  
 60HZ 0/240/120

Grid Level: LN:220V/LL:380V(AC)

IT system-neutral is not grounded

### Grid Mode:

General Standard UL1741 & IEEE1547 CPUC RULE21  
 5RD-UL-1741 CEI\_0\_21\_Internal EN50549\_CZ-PPDS(>16A)  
 Australia\_A Australia\_B Australia\_C AS4777\_NewZealand  
 VDE4105 OVE-Directive R25 EN50549\_CZ\_PPDS\_L16A  
 NR5097 G98 G99 EN50549\_1\_Norway\_133V  
 EN50549\_1\_Norway\_230V Japan\_200VAC\_3P3W  
 CEI\_0\_21\_External CEI\_0\_21\_AreTi Japan\_400VAC\_3P3W  
 Japan\_415VAC\_3P4W EN50549\_1\_Switzerland.

Please follow the local grid code and then choose the corresponding grid standard.  
**Grid level:** there're several voltage levels for the inverter output voltage when it is in off-grid mode.  
 LN:220V/LL:380V(AC), LN:230V/LL:400V(AC).

**IT system:** if the grid system is IT system, then please enable this option. For example, the IT grid system voltage is 230Vac (the Line voltage between any two live lines in a three-phase circuit is 230Vac, and the diagram is as follow) then please enable "IT system" and tick the "Grid level" as LN:230V/LL:400V(AC) as below picture shows.

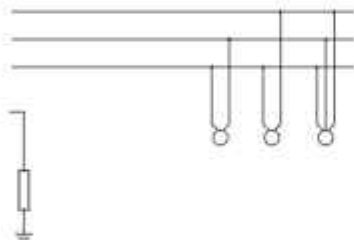

Rc: Large resistance ground resistor. Or the system doesn't have Neutral line.

**Grid Setting/Grid code selection**

Grid Mode: General Standard 0/23

Grid Frequency: 50HZ Phase Type: 0/120/240  
 60HZ 0/240/120

Grid Level: LN:230V/LL:400V(AC)

IT system-neutral is not grounded

**Grid Setting/Connect**

Normal connect Normal Ramp rate: 10s

Low frequency: 48.00Hz High frequency: 51.20Hz  
 Low voltage: 185.0V High voltage: 265.0V

Reconnect after trip Reconnect Ramp rate: 20s

Low frequency: 48.20Hz High frequency: 51.20Hz  
 Low voltage: 187.0V High voltage: 263.0V

Reconnection Time: 80s PF: 1.000

**Normal connect:** The allowed grid voltage/frequency range when the inverter first time connect to the grid.  
**Normal Ramp rate:** It is the startup power ramp.

**Reconnect after trip:** The allowed grid voltage /frequency range for the inverter connects the grid after the inverter trip from the grid.

**Reconnect Ramp rate:** it is the reconnection power ramp.

**Reconnection time:** The waiting time period for the inverter connects the grid again.

**PF:** Power factor which is used to adjust inverter reactive power.

**Grid Setting/IP Protection**

Over voltage UH(10 min. running time): 100.0V

HV3	265.0V	0.10s	HF3	51.20Hz	0.10s
HV2	263.0V	0.10s	HF2	51.20Hz	0.10s
HV1	263.0V	0.10s	HF1	51.20Hz	0.10s
UV3	185.0V	0.10s	UF3	48.00Hz	0.10s
UV2	185.0V	0.10s	UF2	48.00Hz	0.10s
UV1	185.0V	0.10s	UF1	48.00Hz	0.10s

HV1: Level 1 overvoltage protection point;  
 HV2: Level 2 overvoltage protection point; ② 010s—Trip time.  
 HV3: Level 3 overvoltage protection point.

UV1: Level 1 undervoltage protection point;  
 UV2: Level 2 undervoltage protection point;  
 UV3: Level 3 undervoltage protection point.

HF1: Level 1 over frequency protection point;  
 HF2: Level 2 over frequency protection point;  
 HF3: Level 3 over frequency protection point.

UF1: Level 1 under frequency protection point;  
 UF2: Level 2 under frequency protection point;  
 UF3: Level 3 under frequency protection point.

## Grid Setting/F(W)

F(W)

Over frequency		Drop F		40%PE/Hz
Start freq F	50.20Hz	Stop freq F	51.0Hz	
Start delay F	0.00s	Stop delay F	0.00s	

Under frequency		Drop F		40%PE/Hz
Start freq F	49.80Hz	Stop freq F	49.80Hz	
Start delay F	0.00s	Stop delay F	0.00s	

Grid Set4

**FW:** this series inverter is able to adjust inverter output power according to grid frequency.

**Drop F:** percentage of nominal power per Hz

For example, "Start freq F50.2Hz, Stop freq F51.5, Drop F=40%PE/Hz" when the grid frequency reaches 50.2Hz, the inverter will decrease its active power at Drop F of 40%. And then when grid system frequency is less than 50.1Hz, the inverter will stop decreasing output power.

For the detailed setup values, please follow the local grid code.

## Grid Setting/V(W) V(Q)

V(W)  V(Q)

Lock-in/Pn		Lock-out/Pn	
5%	20%	5%	20%

V1	100.0%	P1	100%
V2	110.0%	P2	80%
V3	112.0%	P3	80%
V4	114.0%	P4	40%

V1	94.0%	Q1	44%
V2	97.0%	Q2	0%
V3	100.0%	Q3	0%
V4	100.0%	Q4	44%

Grid Set5

**V(W):** It is used to adjust the inverter active power according to the set grid voltage.

**V(Q):** It is used to adjust the inverter reactive power according to the set grid voltage.

This function is used to adjust inverter output power (active power and reactive power) when grid voltage changes.

**Lock-in/Pn 5%:** When the inverter active power is less than 5% rated power, the VQ mode will not take effect.

**Lock-out/Pn 20%:** If the inverter active power is increasing from 5% to 20% rated power, the VQ mode will take effect again.

For example: V2=110%, P2=80%. When the grid voltage reaches the 110% times of rated grid voltage, inverter output power will reduce its active output power to 80% rated power.

For example: V1=94%, Q1=44%. When the grid voltage reaches the 94% times of rated grid voltage, inverter output power will output 44% reactive output power.

For the detailed setup values, please follow the local grid code.

## Grid Setting/P(Q) P(F)

P(Q)  P(PF)

Lock-in/Pn		Lock-out/Pn	
50%	50%	50%	50%

P1	0%	Q1	2%
P2	2%	Q2	0%
P3	0%	Q3	21%
P4	22%	Q4	20%

P1	0%	P(F)	-0.998
P2	0%	P(F)	0.999
P3	0%	P(F)	0.999
P4	0%	P(F)	0.994

Grid Set6

**P(Q):** It is used to adjust the inverter reactive power according to the set active power.

**P(PF):** It is used to adjust the inverter PF according to the set active power.

For the detailed setup values, please follow the local grid code.

**Lock-in/Pn 50%:** When the inverter output active power is less than 50% rated power, it won't enter the P(Q) mode.

**Lock-out/Pn 50%:** When the inverter output active power is higher than 50% rated power, it will enter the P(Q) mode.

Note: only when the grid voltage is equal to or higher than 1.05times of rated grid voltage, then the P(Q) mode will take effect.

## Grid Setting/LVRT

LVRT

HV3	0%	HV3_T	20.244
HV2	0%	HV2_T	0.04s
HV1	0%	HV1_T	22.11s
LV1	0%	LV1_T	22.02s
LV2	0%	LV2_T	0.04s

Grid Set7

**Reserved:** This function is reserved. It is not recommended.

## 5.9 Generator Port Use Setup Menu

**GEN PORT USE**

**Mode**

Generator Input  GEN connect to Grid Input  
Rated Power: 2000W

SmartLoad Output  On Grid always on  
AC Couple Freq High: 55.00Hz

Micro Inv Input  MI export to Grid cutoff  
OFF: 151.0V  
ON: 134.0V

PORT Batt

↑  
↓  
✕  
✓

**Generator input rated power:** allowed Max. power from diesel generator.

**GEN connect to grid input:** connect the diesel generator to the grid input port.

**Smart Load Output:** This mode utilizes the Gen input connection as an output which only receives power when the battery SOC is above a user programmable threshold.

e.g. **ON: 100%, OFF: 95%:** When the battery bank SOC reaches 100%, Smart Load Port will switch on automatically and power the load connected. When the battery bank SOC < 95%, the Smart Load Port will switch off automatically.

### Smart Load OFF Batt

• Battery SOC at which the Smart load will switch off.

### Smart Load ON Batt

• Battery SOC at which the Smart load will switch on, simultaneously and then the Smart load will switch on.

**On Grid always on:** When click "on Grid always on" the smart load will switch on when the grid is present.

**Micro Inv Input:** To use the Generator input port as a micro-Inverter on grid inverter input (AC coupled), this feature will also work with "Grid-Tied" inverters.

**Micro Inv Input OFF:** when the battery SOC exceeds setting value, Microinverter or grid-tied inverter will shut down.

**Micro Inv Input ON:** when the battery SOC is lower than setting value, Microinverter or grid-tied inverter will start to work.

**AC Couple Freq High:** If choosing "Micro Inv input", as the battery SOC reaches gradually setting value (OFF), during the process, the microinverter output power will decrease linear. When the battery SOC equals to the setting value (OFF), the system frequency will become the setting value (AC couple Freq high) and the Microinverter will stop working.

**MI export to grid cutoff:** Stop exporting power produced by the microinverter to the grid.

**Note:** Micro Inv Input OFF and On is valid for some certain FW version only.

## 5.10 Advanced Function Setup Menu

**Advanced Function**

Solar Arc Fault ON  Backup Delay: 0ms

Over Arc Fault  On (peak-shaving)

System selfcheck  On (peak-shaving)

DRM: 2000 CT Ratio

Signal Island Mode

Asymmetric phase feeding  CGI Report

Func Batt

↑  
↓  
✕  
✓

**Solar Arc Fault ON:** This is only for US.

**System selfcheck:** Disable. this is only for factory.

**Gen Peak-shaving:** Enable When the power of the generator exceeds the rated value of it, the inverter will provide the redundant part to ensure that the generator will not overload.

**DRM:** For AS4777 standard.

**Backup Delay:** When the grid cuts off, the inverter will give output power after the setting time.

For example, backup delay: 3ms. the inverter will give output power after 3ms when the grid cuts off.

**Note:** for some old FW version, the function is not available

**Signal island mode:** If "Signal island mode" is checked and When inverter is in off-grid mode, the relay on the Neutral line (load port N line) will switch ON then the N line (load port N line) will bind to inverter ground.

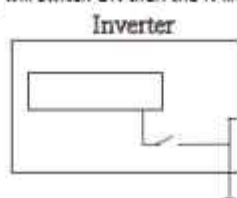

**Asymmetric phase feeding:** If it was checked, the inverter will take power from the grid balance of on each phase (L1/L2/L3) when needed.



## Advanced Function

Parallel      Modbus SW: CC

Meter

Slave

Ex\_Meter For CT

Meter Select:

No Meter    00

CHNT

Eastron

↑ Panel Bats

↓

✕

✓

**Ex\_Meter For CT:** when using zero-export to CT mode, the hybrid inverter can select EX\_Meter For CT function and use the different meters, e.g. CHNT and Eastron.

## 5.11 Device Info Setup Menu

### Device Info.

Inverter ID: 2102199870      Flash

HMI: Ver 1001-8010      MAIN: Ver2002-1046-1707

Alarm Code      Occurred

F13 Grid\_Mode\_changed      2021-06-11 13:17

F23 Tz\_BFOL\_OC\_Fault      2021-06-11 06:23

F13 Grid\_Mode\_changed      2021-06-11 06:21

F58 DC\_VoltLow\_Fault      2021-06-10 13:05

↑ Device Info

↓

✕

✓

This page show Inverter ID, Inverter version and alarm codes.

HMI: LCD version

MAIN: Control board FW version

## 6. Mode

### Mode I: Basic

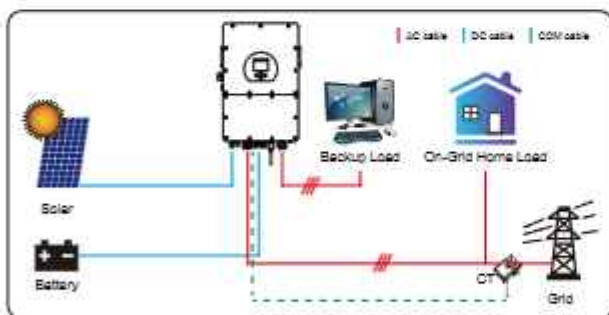

### Mode II: With Generator

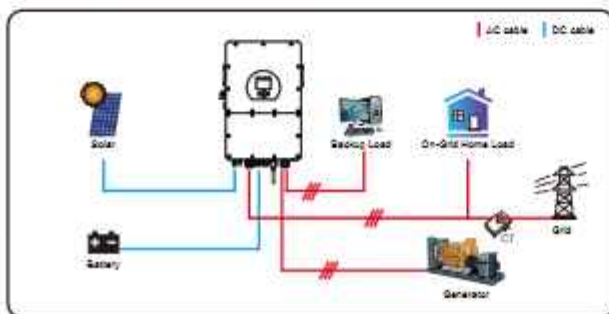

## Mode III: With Smart-Load

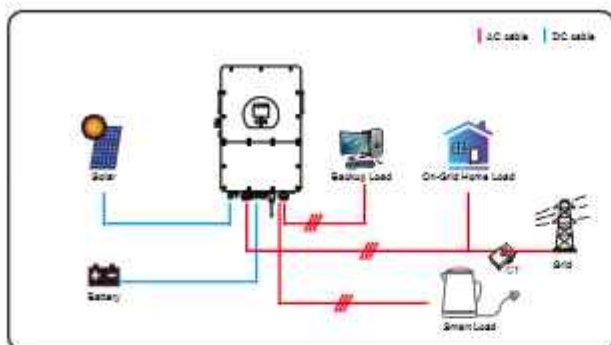

## Mode IV: AC Couple

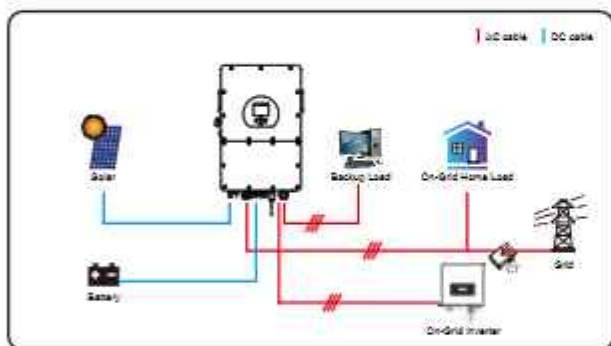

The 1st priority power of the system is always the PV power, then 2nd and 3rd priority power will be the battery bank or grid according to the settings. The last power backup will be the Generator if it is available.

## 7. Limitation of Liability

In addition to the product warranty described alone, the state and local laws and regulations provide financial compensation for the product's power connection (including violation of implied terms and warranties). The company hereby declares that the terms and conditions of the product and the policy can and can only legally exclude all liability within a limited scope.





<i>Error code</i>	<i>Description</i>	<i>Solutions</i>

Chart 7-1 Fault information

---

Under the guidance of our company, customers return our products so that our company can provide service of maintenance or replacement of products of the same value. Customers need to pay the necessary freight and other related costs. Any replacement or repair of the product will cover the remaining warranty period of the product. If any part of the product or product is replaced by the company itself during the warranty period, all rights and interests of the replacement product or component belong to the company.

Factory warranty does not include damage due to the following reasons:

- Damage during transportation of equipment
- Damage caused by incorrect installation or commissioning
- Damage caused by failure to comply with operation instructions, installation instructions or maintenance instructions
- Damage caused by attempts to modify, alter or repair products
- Damage caused by incorrect use or operation
- Damage caused by insufficient ventilation of equipment
- Damage caused by failure to comply with applicable safety standards or regulations
- Damage caused by natural disasters or force majeure (e.g. floods, lightning, overvoltage, storms, fires, etc.)

In addition, normal wear or any other failure will not affect the basic operation of the product. Any external scratches, stains or natural mechanical wear does not represent a defect in the product.

## 8. Datasheet

<i>Model</i>	<i>SUN-5K-SG01HP3-EU-AM2</i>	<i>SUN-6K-SG01HP3-EU-AM2</i>	<i>SUN-8K-SG01HP3-EU-AM2</i>	<i>SUN-10K-SG01HP3-EU-AM2</i>
<b>Battery Input Data</b>				
Battery Type	Lithium-ion			
Battery Voltage Range(V)	160-700			
Max. Charging Current(A)	30		37	
Max. Discharging Current(A)	30		37	
Charging Strategy for Li-ion Battery	Self-adaption to BMS			
Number of Battery Input	1			
<b>PV String Input Data</b>				
Max. PV Input Power(W)	6500	7800	10400	13000
Max. PV Input Voltage (V)	1000			
Start-up Voltage(V)	180			
MPPT Voltage Range(V)	150-850			
Full Load MPPT Voltage RangeV	195-850	195-850	260-850	325-850
Rated PV Input Voltage (V)	600			
Max. Operating PV Input Current(A)	20+20	20+20	20+20	20+20
Max. Input Short-Circuit Current(A)	30+30	30+30	30+30	30+30
No. of MPPT Trackers/No. of Strings per MPPT Tracker	2/1+1			
Max. Inverter Backfeed Current To the Array	0			
<b>AC Input/Output Data</b>				
Rated AC Input/Output Active Power W	5000	6000	8000	10000
Max. AC Input/Output Apparent Power(VA)	5500	6600	8900	11000
Peak Power (off-grid)(W)	1.5 time of rated power, 10 S			
Rated AC Input/Output Current(A)	7.6/7.3	9.1/8.7	12.2/11.6	15.2/14.5
Max. AC Input/Output Current(A)	8.4/8.0	10/9.6	13.4/12.8	16.7/16
Max. Three-phase Unbalanced Output Current(A)	13	13	18	22
Max. Continuous AC Passthrough (grid to load)(A)	40			
Rated Input/Output Voltage/Range(V)	220/380V230/400V 0.85Un-1.1Un			
Grid Connection Form	3L+N+PE			
Rated Input/Output Grid Frequency/Range	50Hz/45Hz-55Hz 60Hz/55Hz-65Hz			
Power Factor Adjustment Range	0.8 leading to 0.8 lagging			
Total Current Harmonic Distortion THDi	<3% (of nominal power)			
DC Injection Current	<0.5% In			
<b>Efficiency</b>				
Max. Efficiency	97.60%			
Euro Efficiency	97.00%			
MPPT Efficiency	>99%			
<b>Equipment Protection</b>				
DC Polarity Reverse Connection Protection	Yes			
AC Output Overcurrent Protection	Yes			
AC Output Overvoltage Protection	Yes			
AC Output Short Circuit Protection	Yes			
Thermal Protection	Yes			
DC Terminal Insulation Impedance Monitoring	Yes			
DC Component Monitoring	Yes			
Ground Fault Current Monitoring	Yes			

Power Network Monitoring	Yes
Island Protection Monitoring	Yes
Earth Fault Detection	Yes
DC Input Switch	Yes
Overvoltage Load Drop Protection	Yes
Residual Current (RCD) Detection	Yes
Surge Protection Level	TYPE II(DC), TYPE II(AC)
<b>Interface</b>	
LCD/LED display	LCD
Communication Interface	WiFi, RS485, CAN
<b>General Data</b>	
Operating Temperature Range	-40 to +60, >45 Derating
Permissible Ambient Humidity	0-100%
Permissible Altitude	2000m
Noise	≤ 55 dB
Ingress Protection (IP) Rating	IP 65
Inverter Topology	Non-Isolated
Over Voltage Category	OVC II(DC), OVC III(AC)
Cabinet size(W*H*D) [mm]	408W*638H*237D (Excluding connectors and brackets)
Weight(kg)	30.5
Installation Style	Wall-mounted
Warranty	5 Years/10 Years the Warranty Period Depends the Final Installation Site of Inverter, More Info Please Refer to Warranty Policy
Type of Cooling	Natural Cooling      Intelligent Air Cooling
Grid Regulation	IEC 61727, IEC 62116, CEI 0-21, EN 50549, NRS 097, RD 140, UNE 217002, OVE-Richtlinie R25, G99, VDE-AR-N 4105
Safety EMC/Standard	IEC/EN 61000-6-1/2/3/4, IEC/EN 62109-1, IEC/EN 62109-2



<b>Model</b>	<b>SUN-12K-SG01HP3-EU-AM2</b>	<b>SUN-15K-SG01HP3-EU-AM2</b>	<b>SUN-20K-SG01HP3-EU-AM2</b>	<b>SUN-25K-SG01HP3-EU-AM2</b>
<b>Battery Input Data</b>				
Battery Type	Lithium-ion			
Battery Voltage Range(V)	160-700			
Max. Charging Current(A)	37			50
Max. Discharging Current(A)	37			50
Charging Strategy for Li-ion Battery	Self-adaption to BMS			
Number of Battery Input	1			
<b>PV String Input Data</b>				
Max. PV Input Power(W)	15600	19500	26000	32500
Max. PV Input Voltage (V)	1000			
Start-up Voltage(V)	180			
MPPT Voltage Range(V)	150-850			
Full Load MPPT Voltage RangeV	340-850	420-850	500-850	625-850
Rated PV Input Voltage (V)	600			700
Max. Operating PV Input Current(A)	26+20	26+30	26+26	26+26
Max. Input Short-Circuit Current(A)	39+30	39+30	39+39	39+39
No. of MPP Trackers/No. of Strings per MPP Tracker	2/2+1		2/2+2	
Max. Inverter Backfeed Current To the Array	0			
<b>AC Input/Output Data</b>				
Rated AC Input/Output Active Power W	12000	15000	20000	25000
Max. AC Input/Output Apparent Power(VA)	13200	16500	22000	27500
Peak Power (off-grid)(W)	1.5 time of rated power, 10 S			
Rated AC Input/Output Current(A)	18.2/17.4	22.8/21.8	30.4/29.0	37.9/36.3
Max. AC Input/Output Current(A)	20/19.2	25/24	33.4/31.9	41.7/39.9
Max. Three-phase Unbalanced Output Current(A)	25	30	35	41.7
Max. Continuous AC Passthrough (grid to load)(A)	80			
Rated Input/Output Voltage/Range(V)	220/380V230/400V 0.85Un-1.1Un			
Grid Connection Form	3L+N+PE			
Rated Input/Output Grid Frequency/Range	50Hz/45Hz-55Hz 60Hz/55Hz-65Hz			
Power Factor Adjustment Range	0.8 leading to 0.8 lagging			
Total Current Harmonic Distortion THDi	<3% (of nominal power)			
DC Injection Current	<0.5% In			
<b>Efficiency</b>				
Max. Efficiency	97.60%			
Euro Efficiency	97.00%			
MPPT Efficiency	>99%			
<b>Equipment Protection</b>				
DC Polarity Reverse Connection Protection	Yes			
AC Output Overcurrent Protection	Yes			
AC Output Overvoltage Protection	Yes			
AC Output Short Circuit Protection	Yes			
Thermal Protection	Yes			
DC Terminal Insulation Impedance Monitoring	Yes			
DC Component Monitoring	Yes			
Ground Fault Current Monitoring	Yes			

Power Network Monitoring	Yes
Island Protection Monitoring	Yes
Earth Fault Detection	Yes
DC Input Switch	Yes
Overvoltage Load Drop Protection	Yes
Residual Current (RCD) Detection	Yes
Surge Protection Level	TYPE II(DC), TYPE II(AC)
<b>Interface</b>	
LCD/LED display	LCD
Communication Interface	WiFi, RS485/CAN
<b>General Data</b>	
Operating Temperature Range	-40 to +60, >45 Derating
Permissible Ambient Humidity	0-100%
Permissible Altitude	2000m
Noise	≤ 55 dB
Ingress Protection(IP) Rating	IP 65
Inverter Topology	Non-Isolated
Over Voltage Category	OVC II(DC), OVC III(AC)
Cabinet size(W*H*D) [mm]	408W*638H*237D (Excluding connectors and brackets)
Weight(kg)	30.5
Installation Style	Wall-mounted
Warranty	5 Years/10 Years the Warranty Period Depends the Final Installation Site of Inverter, More Info Please Refer to Warranty Policy
Type of Cooling	Intelligent Air Cooling
Grid Regulation	IEC 61727, IEC 62116, CEI 0-21, EN 50549, NRS 097, RD 140, UNE 217002, OVE-Richtlinie R25, G99, VDE-AR-N 4105
Safety EMC/Standard	IEC/EN 61000-6-1/2/3/4, IEC/EN 62109-1, IEC/EN 62109-2

## 9. Appendix I

Definition of RJ45 Port Pin for BMS1



BMS1 Port:

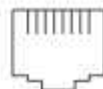
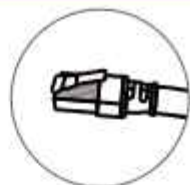

Definition of RJ45 Port Pin for BMS2



BMS2 Port:

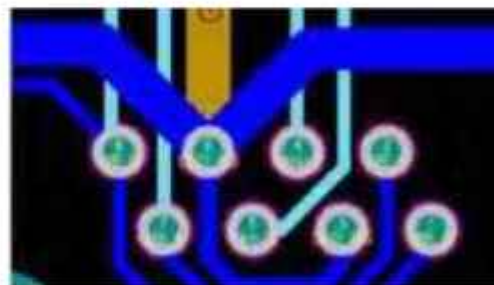

### Definition of RJ45 Port Pin for Meter



Meter Port

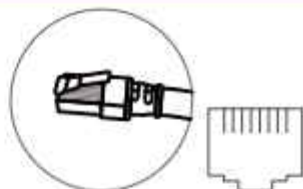

### Definition of RJ45 Port Pin for RS485



RS485 Port

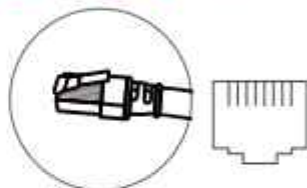

### RS232

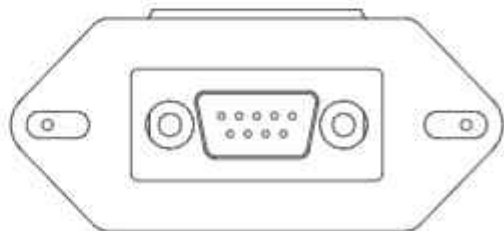

This RS232 port is used to connect the wifi datalogger

## 10. Appendix II

1. Split Core Current Transformer (CT) dimension: (mm)
2. Secondary output cable length is 4m.

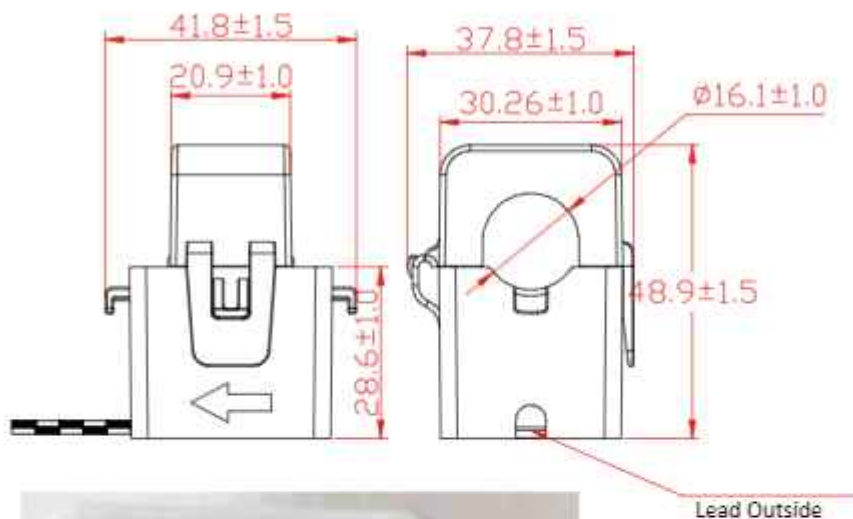

## 11. EU Declaration of Conformity

within the scope of the EU directives

- Electromagnetic compatibility 2014/30/EU (EMC)
- Low Voltage Directive 2014/35/EU (LVD)
- Restriction of the use of certain hazardous substances 2011/65/EU (RoHS)



NINGBO DEYE INVERTER TECHNOLOGY CO., LTD. confirms herewith that the products described in this document are in compliance with the fundamental requirements and other relevant provisions of the above mentioned directives. The entire EU Declaration of Conformity and certificate can be found at <https://www.deyeinverter.com/download/#hybrid-inverter-5>.

## EU Declaration of Conformity

Product: Hybrid Inverter

Models: SUN-5K-SG01HP3-EU-AM2/SUN-6K-SG01HP3-EU-AM2/SUN-8K-SG01HP3-EU-AM2  
SUN-10K-SG01HP3-EU-AM2/SUN-12K-SG01HP3-EU-AM2/SUN-15K-SG01HP3-EU-AM2  
SUN-20K-SG01HP3-EU-AM2/SUN-25K-SG01HP3-EU-AM2Name and address of the manufacturer: Ningbo Deye Inverter Technology Co., Ltd.  
No. 26 South Yongfeng Road, Daji, Bailun, NingBo, China

This declaration of conformity is issued under the sole responsibility of the manufacturer. Also this product is under manufacturer's warranty.

This declaration of conformity is not valid any longer, if the product is modified, supplemented or changed in any other way, as well as in case the product is used or installed improperly.

The object of the declaration described above is in conformity with the relevant Union harmonization legislation: The Low Voltage Directive (LVD) 2014/35/EU, the Electromagnetic Compatibility (EMC) Directive 2014/30/EU, the restriction of the use of certain hazardous substances (RoHS) Directive 2011/65/EU.

References to the relevant harmonized standards used or references to the other technical specifications in relation to which conformity is declared:

LVD:	
EN 62109-1:2010	●
EN 62109-2:2011	●
EMC:	
EN IEC 61000-6-1:2019	●
EN IEC 61000-6-2:2019	●
EN IEC 61000-6-3:2019	●
EN IEC 61000-6-4:2019	●
EN IEC 61000-3-2:2019+A1:2021	●
EN 61000-3-3:2013/A2:2021/AC:2022-01	●
EN IEC 61000-3-11:2019	●
EN 61000-3-12:2011	●
EN 55011:2016/A2:2021	●

Nom et Titre / Name and Title:

Bard Dai  
Senior Standards and Certification Engineer

Au nom de / On behalf of:

Ningbo Deye Inverter Technology Co., Ltd.

Date / Date (yyyy-mm-dd):

2023-10-11

A / Place:

Ningbo, China

EU DeC - v1

Ningbo Deye Inverter Technology Co., Ltd.  
No. 26 South Yongfeng Road, Daji, Bailun, NingBo, China

NINGBO DEYE INVERTER TECHNOLOGY CO., LTD.



30240301002153